



MARBED<sup>®</sup>  
PROFESSIONAL DIESEL SERVICE TOOLS

# 310



MARBED<sup>®</sup>  
PROFESSIONAL DIESEL SERVICE TOOLS

---

## catalog injectors

---

Version 02 - 01-2008 - COPYRIGHT MARBED Srl 2007 all rights reserved

MARBED  
CATALOG

injectors

310



***[www.marbed.com](http://www.marbed.com)***

---

MARBED Srl - Piazza Novelli, 4 - 20129 Milano - Italy

Tel. +39 02.71.49.84 - Fax +39 02.70.10.26.67

e-mail [info@marbed.com](mailto:info@marbed.com)

# Wrenches for pipes



**9059**

17 mm hexagon T wrench  
450 mm length for pipe nuts



**9060**

17 mm box T wrench  
450 mm length for pipe nuts



**9061**

19 mm hexagon T wrench  
450 mm length for pipe nuts



**9061-A**

19 mm box T wrench  
450 mm length for pipe nuts



**9403**

14 mm T wrench  
230 mm length for pipe nuts



**9749-A**

Wrench with sliding rod  
250 mm length hexagon 17 mm  
for cars pipe nuts



**9749-B**

17 mm hexagonal head wrench  
250 mm length for cars pipe nuts



**9508**

17 mm hexagon wrench  
270 mm length for trucks pipe nuts (ex FIAT 190)



**9693**

17 mm hexagon wrench  
240 mm length for coach pipe nuts (ex FIAT 370)



**9693-B**

17 mm hexagon wrench  
180 mm length for cars pipe nuts (ex FIAT RITMO)



**9071**

Open box wrench  
for pipe nuts 17/19



**9073-A**

Triplex use wrench 13 mm



**9073-B**

Triplex use wrench 14 mm



**9073-C**

Triplex use wrench 17 mm



**9073-D**

Triplex use wrench 19 mm



**MARBED**<sup>®</sup>  
PROFESSIONAL DIESEL SERVICE TOOLS

# 9510-A



9510-A - BOX WITH PULLER FOR NOZZLE HOLDERS

## 9510-A

Box with puller and reductions  
for all nozzle holders  
(12 articles- 13pieces)

<b>9047</b>	1	Puller
<b>9468</b>	1	Reduction for 9047
<b>9469</b>	1	Reduction for 9047
<b>9470</b>	1	Reduction for 9047
<b>9603</b>	1	Reduction for 9047
<b>9050</b>	1	Reduction for 9047
<b>9258</b>	1	Reduction for 9047
<b>9049</b>	1	Reduction for 9047
<b>9051</b>	1	Reduction for 9047
<b>9050-A</b>	1	Reduction for 9047
<b>8096</b>	1	Reduction for 9047
<b>8096-A</b>	1	Reduction for 9047

Pieces



**9047**

Nozzle holder puller  
with joint head



**9468**

Reduction for 9047  
for IVECO nozzle holders - 8 x 1



**9469**

Reduction for 9047  
for IVECO nozzle holders - 8 x 1,25



**9470**

Reduction for 9047  
for CAV nozzle holders - 8 x 0,75



**9603**

Reduction for 9047  
for SCANIA nozzle holders - 14 x 1,5



**9050**

Reduction for 9047  
for nozzle holder precombustion chamber  
MERCEDES - Ø 22



**9258**

Reduction for 9047  
for SIGMA RM-RMS nozzle holder - 22 x 1,5



**9049**

Reduction for 9047  
for IVECO nozzle holders - 16 x 1,5



**9051**

Reduction for 9047  
for nozzle holders on tractors



**9050-A**

Reduction for nozzle holder puller **9047**  
precombustion chamber MERCEDES 250 TD - 17 x 1



**8096**

Reduction for 9047  
for OPEL 2000 nozzle holders



**8096-A**

Reduction for 9047  
for common rail nozzle holders



**MARBED**<sup>®</sup>  
PROFESSIONAL DIESEL SERVICE TOOLS

# 9510



9510-A - BOX WITH PULLER FOR NOZZLE HOLDERS

## 9510

Box with puller and reductions  
for all nozzle holders  
(9 articles- 10 pieces)

<b>9047</b>	1	Puller
<b>9468</b>	1	Reduction for 9047
<b>9469</b>	1	Reduction for 9047
<b>9470</b>	1	Reduction for 9047
<b>9603</b>	1	Reduction for 9047
<b>9050</b>	1	Reduction for 9047
<b>9258</b>	1	Reduction for 9047
<b>9049</b>	1	Reduction for 9047
<b>9051</b>	1	Reduction for 9047

Pieces



**9047**

Nozzle holder puller  
with joint head



**9468**

Reduction for 9047  
for IVECO nozzle holders - 8 x 1



**9469**

Reduction for 9047  
for IVECO nozzle holders - 8 x 1,25



**9470**

Reduction for 9047  
for CAV nozzle holders - 8 x 0,75



**9603**

Reduction for 9047  
for SCANIA nozzle holders - 14 x 1,5



**9050**

Reduction for 9047  
for nozzle holder precombustion chamber  
MERCEDES - Ø 22



**9258**

Reduction for 9047  
for SIGMA RM-RMS nozzle holder - 22 x 1,5



**9049**

Reduction for 9047  
for IVECO nozzle holders - 16 x 1,5



**9051**

Reduction for 9047  
for nozzle holders on tractors



# Injector pullers



**9039**

Nozzle holder puller 20x1,5 mm  
(SIGMA, FB)



**9046**

Strong tensile stress puller  
for FB, OMT, OMAP nozzle holder  
on FIAT IVECO  
*(after the assembly of the exhausting union)*



**9899**

Very high traction steel puller for  
bar nozzle holders on  
IVECO, MERCEDES, MAN, FIAT, RENAULT,  
VOLVO, SCANIA ecc..  
*consisting of a threaded pin 14x1,5  
and one 12x1,5*



**9899-A**

Very high traction mini-puller for bar nozzle holders  
on FIAT DUCATO ID, DAILY ID, FORD TRANSIT ID and  
for all those nozzle holders where there is an hindrance  
in extraction area: connectors, pipes,  
preheater and so on  
*consisting of a threaded pin 14x1,5 and one 12x1,5*  
**REMARK: Nozzle holders always blocked in their  
housing due to fouling and rust caused by water**

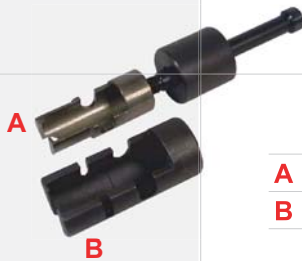

**9044-A**

Nozzle holder puller for STANADYNE, CATERPILLAR  
and FORD TRANSIT

- |          |               |   |
|----------|---------------|---|
| <b>A</b> | <b>9044</b>   | STANADYNE nozzle holder puller (JOHN DEERE) |
| <b>B</b> | <b>9044-B</b> | Reduction for CATERPILLAR and FORD TRANSIT  |

## Clamps

Clamps for the dismounting of nozzle holders nuts



FIAT OM (615)

**9023**



SAME Tractors

**9024**



FIAT UNIC  
(SIGMA nozzle holder on OM 150)

**9022**



IVECO (50 NC, OM 40)

**9355**



FIAT 130, OM 100, OM 120  
(**BOSCH KBEL 82S166/4** nozzle holder on CP3 - CO3 engines)

**9535**



SCANIA

**9340**



PERKINS, FORD TRANSIT

**9340-A**



LAND ROVER, LEYLAND

**9725**



IVECO  
(OMAP OMT nozzle holder on FIAT 170, 190...)

**9786**



**9787**

MERCEDES SCANIA  
(tracks and coaches)



**9788**

MENARINI coaches  
(BOSCH **KBEL 103P21** nozzle holder  
on MERCEDES engines)

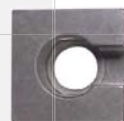

**9363**

BOSCH **KBEL Z 150S67** nozzle holder  
on ISOTTA FRASCHINI engines



**9365**

FORD 5000



**9571-A**

VW POLO, MERCEDES  
(ISUZU nozzle holder, hexag. 22 mm)

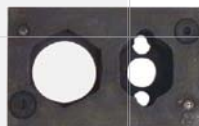

**9571-B**

ALFA ROMEO VM, ROVER  
(BOSCH nozzle holder, hexag. 28 mm)

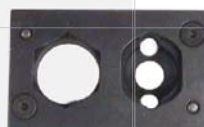

**9571-C**

GOLF TD  
(BOSCH nozzle holder, slot 28 mm)



**9571-D**

MERCEDES SPRINZER, DEUTZ  
(BOSCH nozzle holder, hexag. 10 mm and 11 mm)



**9571-E**

NISSAN  
(MITSUBISHI nozzle holder, hexag. 19 mm and 22 mm)

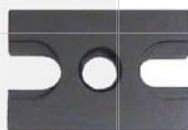

**9571-F**

BOSCH COMMON RAIL



**8026**

MERCEDES MAN



**9784**

CITROEN (BX, CX), FIAT 242



**9571**

VW GOLF, PEUGEOT TABLOT, ...  
(CAV nozzle holders)



**9512**

FIAT 131 - 132, RITMO, VM (ALFETTA)



**9509**

OPEL



**9397-A**

MERCEDES, OPEL, VOLKSWAGEN,  
FIAT (127, REGATA,...), VOLVO, AUDI, ...



**9512-A**

FIAT CROMA



**MARBED**<sup>®</sup>  
PROFESSIONAL DIESEL SERVICE TOOLS

# 10019-K

10019 - TOOLS FOR INJECTORS DISMOUNTING

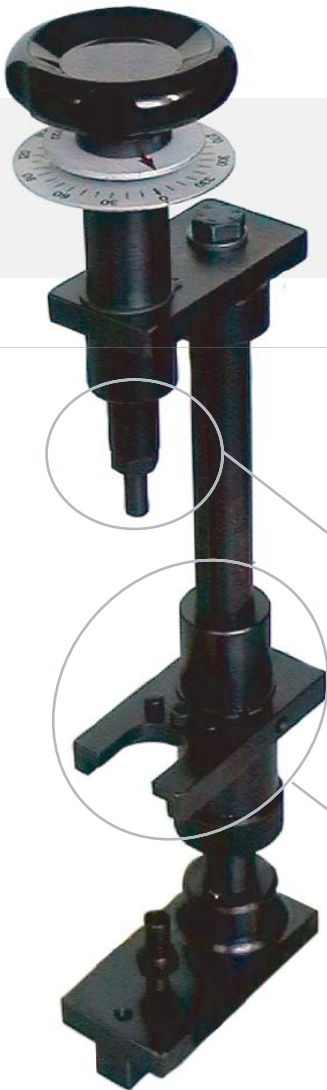

## 10019-K

Professional tool do tismount unit injetors, common rail and 2-spring injectors. It replace the previous 10019. It includes 7 interfacing adapters *Additional interfaces to be ordered as optional*

### Adapters

Size	Included in 10019-K
<b>T</b>	✓
<b>S</b>	✓

## 10019-34

New body to update the previous 10019

# 10019-12



## 10019-12

Suitable to any test bench vice  
It use the same interfacing adapters of 10019-K  
*Additional interfaces to be ordered as optional*  
*Similar of our arts 8136 e 8136-A*

CODE	NOTES	INCLUDED IN 10019-K
1  10019-1		✓
2  10019-2		✓
3  10019-3		✓
4  10019-4		✓
5  10019-5		✓
6  10019-6		✓
7  10019-7		✓
8  10019-8		✗
9  10019-9		✗
10  10019-11		✗
11  10019-22	HEUI WITH 2 BOBBINES	✗
12  10019-20	HEUI ISUZU	✗
13  10019-10	UIS LUPO VOLKSWAGEN	✗



# Wrenches for injectors

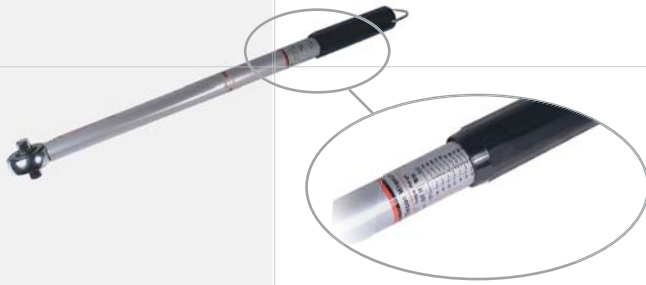

**9785-A**

Dynamometrical wrench  
0,5-7 kgm



**9697**

Box with 9 wrenches:

<b>Hexag.</b>	14 mm
	19 mm
	20 mm
	22 mm
	27 mm
<b>Eyelet</b>	mm 22 x 19
	mm 22 x 24,5
	mm 20x22
	mm 19 fresata aperta



**8104**

Wrench to dismount nozzle holders on  
MITSUBISHI TD, TOYOTA COROLLA  
mm 21



**9536-B**

Disassembly wrench of first instrumental  
injector holder equipped with sensor  
connected to the gearbox (on MERCEDES C)  
hexag 22 mm



**9536-B1**

Allen wrench for disassembly of  
nozzle holder with electronic adjustment  
on PEUGEOT 106 and MERCEDES  
hexag 22 mm



**9589**

Wrench for SCANIA nozzle holder  
hexag. 22 mm - 1/2" square  
length: 150 mm



**9536-A**

Extended wrench for nozzle holders on  
MERCEDES serie C  
hexag. 22 mm  
length: 150 mm



**9536-C**

Allen wrench - short - for disassembly  
of ISUZU nozzle holders on OPEL  
hexag. 22 mm



**9737**

Wrench for VW GOLF TD, FIAT RITMO nozzle holder  
hexag. 27 mm - 1/2" square  
length: 80 mm



**9755**

Opened wrench for SCANIA nozzle holder  
27 mm - 1/2" square  
length: 80 mm



**9755-B**

Reinforced wrench open, for BOSCH nozzle holders  
with sensor, on BMW, FIAT, LANCIA K



**9755-N**

Nozzle holder disassembly wrench (NISSAN)  
mm 27



**9031**

27 mm wrench for nozzle holders  
length: 280 mm



**9514**

Wrench for BEDFORD, FIAT 127 nozzle holders  
hexag. 27 mm, 1/2" square  
length: 160 mm



**9755-AR**

Hexagonal wrench for injectors holder instrumental  
with reduced guide for VM ROVER engines  
mm 28





**9755-A**

Hexagonal reinforced open wrench, for BOSCH nozzle holders with sensot, mounted on ALFA ROMEO VM, ROVER  
*28 mm*



**9536**

Wrench for MERCEDES trucks nozzle holder  
*hexag. 28 mm, 1/2" square  
length: 80 mm*



**9354**

Wrench for nozzle holders on MERCEDES trucks  
*30 mm hexag.  
length: 175 mm*



**9056**

Wrench to dismount the nozzle holder on CATERPILLAR D4, D6, D7, D8 etc



**9404**

Locking nozzle nut wrench for CUMMINS nozzle holders



**9400**

Patented wrench to demount the check nozzle nuts, the inlet and the exhaust unions of IVECO nozzle holders  
*hex 17mm - hex 19mm - hex 20mm*



**9400-A**

Patented wrench to demount the nozzle holder check nuts IVECO, MERCEDES, MAN  
*slot 19mm - slot 20mm - slot 22mm*



**9400-B**

Patented wrench to demount the nozzle holder check nuts FIAT DUCATO TD, DAILY, FORD TRANSIT  
*hex 17mm - hex 19mm - hex 20mm*

**8025**

Puller for disassembly of BOSCH nozzle holders with electronic adjustment on MERCEDES MAN trucks

**8025-A**

Original wrench for disassembly of BOSCH nozzle holders on MERCEDES MAN trucks

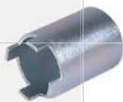
**8117**

4 teeth wrench for disassembly of fixed nut in FIAT DOBLO injector holder pre-camber

**9415**

Toothed wrench for ring nut nozzle holder locking on MERCEDES, MAN trucks

**9415-A**

Toothed wrench for ring nut nozzle holder locking on MERCEDES, MAN trucks with 1/2" square

**9528**

Toothed wrench for ring nut nozzle holder locking on MERCEDES, MAN trucks with 1/2" square

**9536-M**

Wrench for disassembling fixed ring nut of nozzle holder on MERCEDES trucks 11.13  
 $\varnothing 31,5 \text{ mm}$

**9536.M1**

---

**9537**

Toothed wrench for ring nut nozzle holder locking on FIAT CROMA T.D. - I.D. with 1/2" square

**9885**

Removing wrench for the precombustion chamber ring on MERCEDES 250 D



**9886**

Toothed wrench to remove and extract metal ring  
and nozzle holder on MERCEDES trucks



**9147-B**

Hook wrench for fixed nut on precombustion chamber  
nozzle holders on FIAT BRAVO and BRAVA



**9147**

Assembling and disassembling wrench of the fixing  
ring of precombustion chamber on MERCEDES



**9147-A**

Assembling and disassembling wrench of the fixing  
ring of precombustion chamber on FIAT (127/D, UNO D etc)

## Two handles spanners

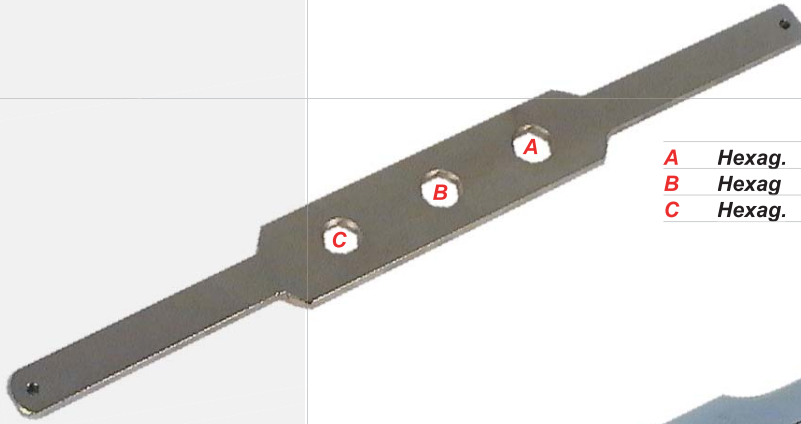
**9351**

<b>A</b>	Hexag.	20 mm
<b>B</b>	Hexag	19 mm
<b>C</b>	Hexag.	17 mm

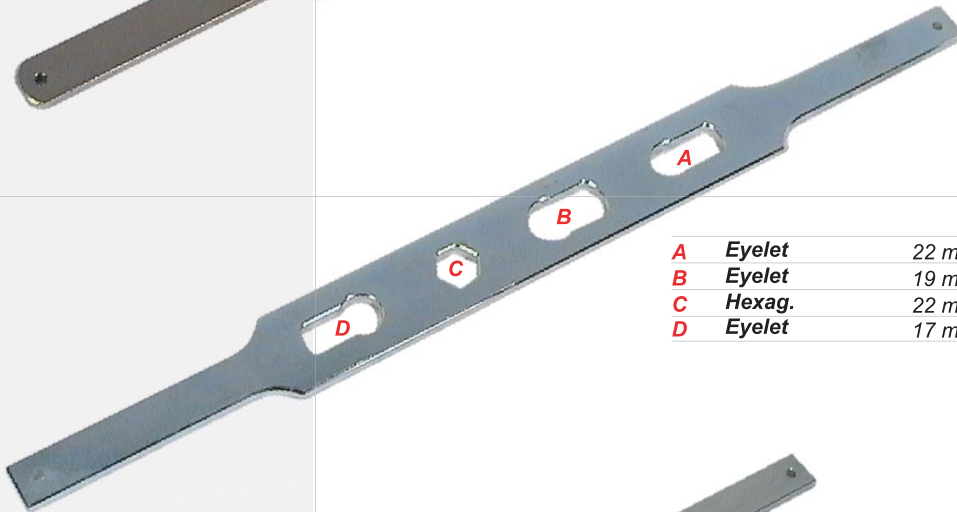
**9352**

<b>A</b>	Eyelet	22 mm
<b>B</b>	Eyelet	19 mm
<b>C</b>	Hexag.	22 mm
<b>D</b>	Eyelet	17 mm

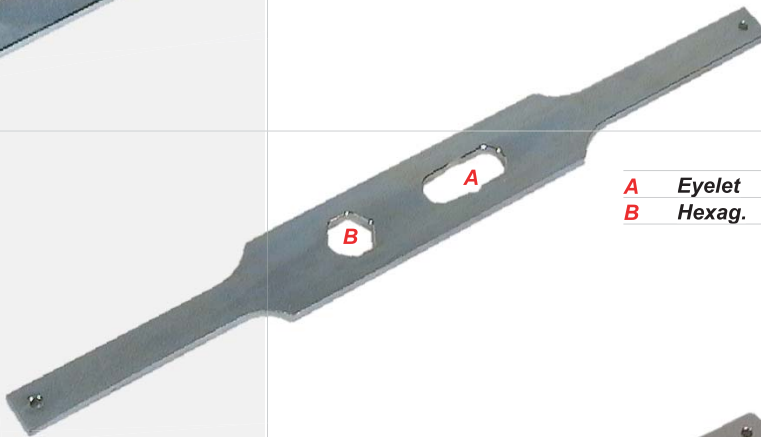
**9353**

<b>A</b>	Eyelet	20 mm
<b>B</b>	Hexag.	25 mm

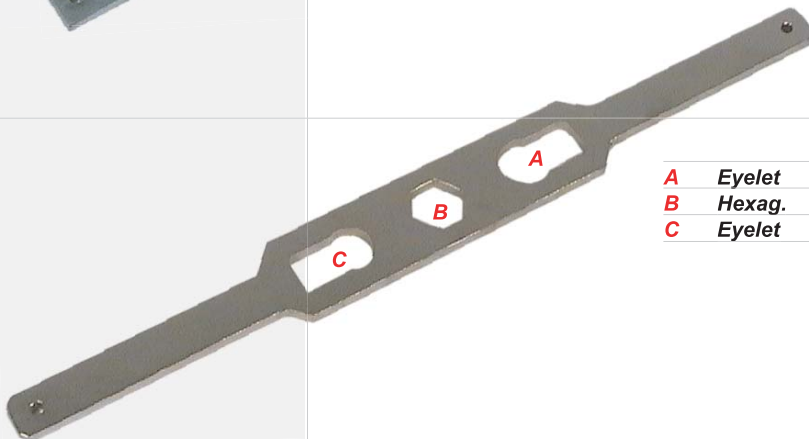
**9353-A**

<b>A</b>	Eyelet	24 mm
<b>B</b>	Hexag.	27 mm
<b>C</b>	Eyelet	22 mm



**9785**

Dynamometrical wrench  
7-13 kgm



**9785-A**

Dynamometrical wrench  
0,5-7 kgm

**1/2" square wrenches**

To be used with  
*our art 9785-A*



**9072**

17 mm



**9070**

19 mm



**9323**

22 mm



**9324**

23 mm



**9325**

24 mm



**9325-A**

25 mm

# Ultrasonic Cleaner



**9698-VL3**

Transistorized ultrasonic cleaning machine with automatic setting. The container is supplied with a heater, timer and with an inox stainless basket to contain parts, and with 4 special fluid bottles  
*Made in the usa*



**9698-C**

Biodegradable fluid for diesel and electronic components in a 5 litres jug



**9698-A**

Biodegradable fluid for diesel and electronic components in a 0,5 litres bottle



**9896**

Stainless steel plate for electro-nozzles



**MARBED**<sup>®</sup>  
PROFESSIONAL DIESEL SERVICE TOOLS

# 9700



9700 - NOZZLE CLEANING TOOL IN KIT

## 9700

Nozzle cleaning tool in kit

# 9700

## Nozzle cleaning tool in kit



<b>9691</b>	1	Little brass brush
<b>9002</b>	2	Twist drill
<b>9003</b>	1	Piano wire
<b>9004</b>	1	10 stubs conical needle
<b>9005</b>	1	Steel wire brush
<b>9006</b>	1	Hair brush
<b>9007</b>	1	Spindle
<b>9008</b>	1	Spindle
<b>9009</b>	1	Spindle
<b>9252</b>	1	Zero closing pliers
<b>9256</b>	1	Closing pliers
<b>9688</b>	1	Magnifying lens
<b>9689</b>	1	Enveloped lens
<b>9013</b>	1	Polishing and emery paste
<b>9014</b>	1	Polishing and emery paste
<b>9015</b>	1	Polishing and emery paste
<b>9017</b>	1	Lapping paste
<b>9018</b>	1	Lapping paste

Pieces





Little brass bush for nozzles

**9691**



Twist drill for the cleaning of the nozzle cup  
*1,2 mm*

**9002**



Piano wire packet for nozzle holders  
*in three sizes*  
*0,12 - 0,20 - 0,30*

**9003**



Little case with 10 conical stub needles  
*in different sizes*  
*0,05 - 0,07 - 0,10*

**9004**



Steel brush to clean the nozzle stop nuts

**9005**



Hair brush for nozzle cleaning

**9006**



Heavy head spindle  
*with pliers Ø 3 mm*

**9007**



Spindle with zero closing for piano wire  
and stubs needles

**9008**



New spindle U.T. Nozzles  
(MERCEDES, VOLVO, BMW)  
*with pliers Ø 2,2 mm*

**9009**

**9252**

Zero closing pliers  
for our artt. 9007 e 9009



**9256**

Ø 3 mm pliers  
for our artt. 9007 e 9009



**9688**

Magnifying lens



**9689**

Enveloped lens for nozzle inspection



**9013**

Polishing and emery paste  
**grain 320**  
*peso netto 5 gr.*



**9014**

Polishing and emery paste  
**grain 400**  
*net weight 5 grs.*



**9015**

Polishing and emery paste  
**grain 600**  
*net weight 5 grs.*



**9017**

Lapping compound  
**Paris Red original diamant**  
*net weight 5 grs.*



**9018**

Lapping compound  
**Chrome Green**  
*net weight 5 grs.*





10016-P - SPECIAL TOOL FOR NOZZLE CLEANING

## 9700-A

Special tools for nozzle cleaning  
(KDEP 2900  
BH 0 986 611 140)

<b>9700-1</b>	1	Cleaning pin
<b>9700-2</b>	1	Cleaning pin
<b>9700-3</b>	1	Cleaning pin
<b>9700-4</b>	1	Metal brush
<b>9988</b>	1	Pin vice
<b>9700-6</b>	1	Inserting pin tools
<b>9700-7</b>	6	12 pins set

Pieces



Cleaning pin **9700-1**



Cleaning pin **9700-2**



Cleaning pin **9700-3**



Metal brush **9700-4**



Pin vice **9008**



Inserting pin tools **9700-6**



12 pins set **9700-7**

- Ø 3
- Ø 2,8
- Ø 2,6
- Ø 2
- Ø 1,9
- Ø 1,8
- Ø 1,5
- Ø 1,4
- Ø 1,3
- Ø 1,2
- Ø 1,1
- Ø 1

# Hand injector tester



**9375**





**9375-S**

**9375-SL**

Hand injector similar BOSCH tester  
 with isolating manometric valve  
*Different manometers (see the table below)*

9375 - HAND INJECTOR TESTER

## Spare parts







PUMP	MANOMETER	TANK	FILTER
<b>9375</b> <i>EFEP 60H</i> <i>BH 0 681 200 502</i>	 <b>9148-H</b> <i>0-400 BAR</i> <i>BH 1 687 231 004</i>	 <b>9375-T</b>	 <b>9375-F</b>
<b>9375-S</b>	 <b>9148-S</b> <i>0-600 BAR blinded</i>		
<b>9375-SL</b>	 <b>9148</b> <i>0-600 BAR gliceroil</i> <i>BH 1 687 231 006</i>		



**TP03**





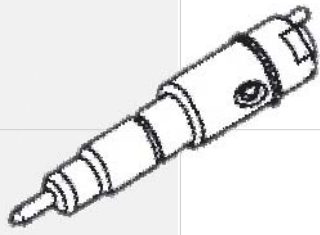

Electronic add on unit  
 to test 2 spring  
 and traditional injectors

# Injector tester adapter

CODE	NOTES	APPLICATION
1  <b>9032</b>	Injector tester	<i>UNIVERSAL</i>
2  <b>9033</b>	Injector tester	<i>SIGMA, F.B.</i>
3  <b>9034</b>	Injector tester	<i>SIGMA, F.B.</i>
4  <b>9227</b>	Pipe for injection test pump	<i>JOHN DEERE, CATERPILLAR</i>
5  <b>9228</b>	Injector test pump reduction	<i>CATERPILLAR U.T.</i>
6  <b>9259</b>	Injector tester	<i>SIGMA RM-RMS 22 x 1,5</i>



# Injector tester adapter

	CODE	Ø	PULLER	APPLICATION
1	 <b>9227-A</b>	24	in inches	<i>GM on RENAULT MACK trucks</i>
2	 <b>9227-B</b>	26	8 x 1,25	<i>MERCEDES ATROS</i>
3	 <b>9227-S1</b>	26	NO	<i>TECTOR</i>
4	 <b>9227-E</b>	27,5	in inches	<i>GM on RENAULT MACK 480 trucks</i>
5	 <b>9227-C</b>	29	NO	<i>MAN</i>
6	 <b>9227-D</b>	32	NO	<i>RENAULT PREMIUM</i>

# Quick connection for pump tester

**9148-B**

Patented quick connection for injectors with thread **12 x 1,5 and 14 x 1,5** for test injector pump

**9148-C**

Patented quick connection for injectors with thread **16 x 1,5 and 20 x 1,5** for test injector pump

**9148-D**

Patented quick connection for injectors with thread **18 x 1,5 and 22 x 1,5** for test injector pump

## WAY OF USE



Approach the tool head



Lock the tool ring



Rotate clockwise the handle tool to secure



Rotate anticlockwise and release the tool ring

## Spare parts

**9052**

Pipe for quick connections **9148-B** with nylon head

**9053**

Nylon head for quick connections **9148-B**





# Boxes of mixed spacers for nozzle holders



**9791**  
BOSCH  
nozzle holders  
wide type

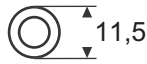



**9792**  
CAV  
nozzle holders  
narrow type



1	0,80	<b>9791-1</b>	<b>9792-21</b>
2	0,85	<b>9791-2</b>	<b>9792-22</b>
3	0,90	<b>9791-3</b>	<b>9792-23</b>
4	0,95	<b>9791-4</b>	<b>9792-24</b>
5	1,00	<b>9791-5</b>	<b>9792-1</b>
6	1,05	<b>9791-6</b>	<b>9792-2</b>
7	1,10	<b>9791-7</b>	<b>9792-3</b>
8	1,15	<b>9791-8</b>	<b>9792-4</b>
9	1,20	<b>9791-9</b>	<b>9792-5</b>
10	1,25	<b>9791-10</b>	<b>9792-6</b>
11	1,30	<b>9791-11</b>	<b>9792-7</b>
12	1,35	<b>9791-12</b>	<b>9792-8</b>
13	1,40	<b>9791-13</b>	<b>9792-9</b>
14	1,45	<b>9791-14</b>	<b>9792-10</b>
15	1,50	<b>9791-15</b>	<b>9792-11</b>
16	1,55	<b>9791-16</b>	<b>9792-12</b>
17	1,60	<b>9791-17</b>	<b>9792-13</b>
18	1,65	<b>9791-18</b>	<b>9792-14</b>
19	1,70	<b>9791-19</b>	<b>9792-15</b>
20	1,75	<b>9791-20</b>	<b>9792-16</b>
21	1,80	<b>9791-21</b>	<b>9792-17</b>
22	1,85	<b>9791-22</b>	<b>9792-18</b>
23	1,90	<b>9791-23</b>	<b>9792-19</b>
24	1,95	<b>9791-24</b>	<b>9792-20</b>

**9372**

Box with 1500 mixed distance spacers for nozzle holders



CODE				APPLICATION	
1	<b>9372 - 01</b>	11,5	5,1	0,05	<i>Nozzle holders FIAT car (ex. STRADA)</i>
2	<b>9372 - 02</b>	11,5	5,1	0,1	
3	<b>9372 - 03</b>	11,5	5,1	0,2	
4	<b>9372 - 04</b>	10	3	0,05	<i>Nozzle holders BOSCH car</i>
5	<b>9372 - 05</b>	10	3	0,1	
6	<b>9372 - 06</b>	10	3	0,2	
7	<b>9372 - 07</b>	9	4,2	0,05	<i>Nozzle holders CAV car</i>
8	<b>9372 - 08</b>	9	4,2	0,1	
9	<b>9372 - 09</b>	9	4,2	0,2	
10	<b>9372 - 10</b>	11	7	0,05	<i>Nozzle holders BOSCH car (ex. MERCEDES)</i>
11	<b>9372 - 11</b>	11	7	0,1	
12	<b>9372 - 12</b>	11	7	0,2	
13	<b>9372 - 13</b>	7,5	3,6	0,05	<i>Nozzle holders NIPPONDENSO and ZEXEL</i>
14	<b>9372 - 14</b>	7,5	3,6	0,1	
15	<b>9372 - 15</b>	7,5	3,6	0,2	

# 9793 - flame damper



## 9793

Box with flame dampers  
and washers for nozzle holders  
(512 pieces)

CODE				NOTES	
1	<b>9793 - 01</b>	20,5	5,5	diff. 0,5	<i>Flame damper FIAT UNO</i>
2	<b>9793 - 02</b>	20,5	5,5	diff. 0,2	<i>Flame damper VW GOLF</i>
3	<b>9793 - 03</b>	17,5		h. 13	<i>Flame damper VM (ALFA)</i>
4	<b>9793 - 04</b>	20,5	8	diff. 0,5	<i>Flame damper MERCEDES</i>
5	<b>9793 - 05</b>	16		h. 13	<i>Flame damper FIAT SOFIM - RITMO</i>
6	<b>9793 - 06</b>	17,3		h. 14	<i>Flame damper OPEL</i>
7	<b>9793 - 07</b>	14	5	1,1	<i>Plate flame trap FORD</i>
8	<b>9793 - 08</b>	14	5	1,1	<i>Plate flame trap OPEL</i>
9	<b>9793 - 09</b>				<i>Brass flame damping washer SOFIM</i>
10	<b>9793 - 10</b>				<i>Brass flame damping washer OPEL, VM, MERCEDES</i>
11	<b>9793 - 11</b>	21	17	1,5	<i>Brass washer for nozzle base (BMW ecc.)</i>
12	<b>9793 - 12</b>				<i>Iron rubber plug for nozzle holder drain terminal (BOSCH-CAV)</i>
13	<b>9793 - 13</b>	6			<i>Brass washers</i>
14	<b>9793 - 14</b>	8			<i>Brass washers</i>

## 9794

Stroke puller for flame traps

## 9794-A

Bare male

## 9794-B

Conical reduction for puller for flame dumper  
after the notching of the thread  
when the extraction is difficult



**9236-A**

Light probe with magnifying lens  
for the inspection of the injector body



**9790**

Tool-kit to insert and pull the nozzle holder dowel bolt  
It enables a right extraction of the old broken  
bolt and the insertion of the new one at fixed level

**It includes:**

*Drill die*

*Drilling die*

*Centering bishes in three interchangeable  
sizes fo nozzle holders*

*Drill table*

*Inserting pin for nozzle dowel bolts*

*Elastic nozzle dowel bolts (10 pieces)*

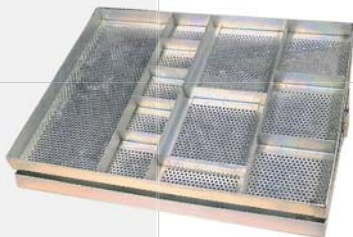

**9796-A**

Store-box for components parts 8 cyl.  
of disassembling nozzle holders  
and pumps

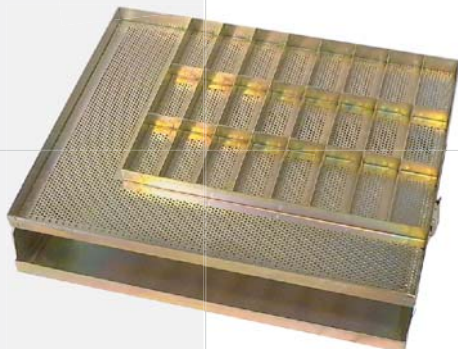

**9796-B**

Store-box for components parts  
of disassembling nozzle holders  
and pumps



**9263**

Injector protrusion gauge



**9414-A**

Expansion bend for nozzle holder  
copper jackets



**9257**

Ø 2,2 mm pliers  
for our art. 9007 e 9009

# Motoring Reamer



**9000**

Reamer with helical conical miller and  
Ø 0,20 mm shimming aluminium washers  
for nozzle copper cases

**9640**



*Conical miller - IVECO - Ø 22 mm (2 pieces in box)*



**9000-A**

Reamer with helical millers and  
Ø 0,20 mm shimming aluminium washers  
for nozzle copper cases

**9640**

*Conical miller - IVECO - Ø 22 mm (2 pieces in box)*

**9640-A**

*Conical miller - IVECO 115/17 - Ø 25 mm*

**9524**

*Conical miller - IVECO 50NC - 90NC - Ø 22 mm*

**9524-A**

*Conical miller - VOLVO - MAN - Ø 25 mm*





**MARBED**<sup>®</sup>  
PROFESSIONAL DIESEL SERVICE TOOLS

# 9376

## Press for pipe delivery diesel oil cones



**9376**

Press with partial hydraulic up setting  
for pipe delivery diesel oil cone  
it includes the kit for Ø 6 mm cones (**9093**)  
*Pressure up to 50 quintals*  
*To apply to the bench vice*

### Spare parts







**9093**

Matrix die kit for 6 mm pipe

**9102**

Matrix die kit for 8 mm pipe

<b>9093</b>	<b>9102</b>	<b>( 9093 )</b> <b>9102 )</b>
6 mm pipe	8 mm pipe	

	Matrix die for pipe	WB 5	WB 34	<b>-A</b>
	Pipe slide	WB 6	WB 29	<b>-B</b>
	Sleeve	WB 7	WB 30	<b>-C</b>
	Spacer	WB 8	WB 31	<b>-D</b>
	Loosening sleeve	WB 9	WB 32	<b>-E</b>
	OR kit for hydraulic oil seal			<b>-F</b>



**9111**

Tube bender jig



**9897**

Tool with 14 ground gauges for the  
checking of ISO tubings  
*tollerance of 1 tenth f.e.*



***[www.marbed.com](http://www.marbed.com)***

---

MARBED Srl - Piazza Novelli, 4 - 20129 Milano - Italy

I. +39 02.71.49.84 - Fax +39 02.70.10.26.67

e-mail [info@marbed.com](mailto:info@marbed.com)