



MARBED[®]
PROFESSIONAL DIESEL SERVICE TOOLS

222



MARBED[®]
PROFESSIONAL DIESEL SERVICE TOOLS

catalog

DELPHI rotary pumps and other

Version 02 - 01-2008 - COPYRIGHT MARBED Srl 2007 all rights reserved

MARBED
CATALOG

DELPHY rotary pumps and other

222



www.marbed.com

MARBED Srl - Piazza Novelli, 4 - 20129 Milano - Italy

I. +39 02.71.49.84 - Fax +39 02.70.10.26.67

e-mail info@marbed.com



MARBED[®]
PROFESSIONAL DIESEL SERVICE TOOLS

9356-A

Swivel vice
for flanges BOSCH
PES..A, VE, VA pumps



9356-A

Swivel vice for operative flanges
of PES...A, VE, VA pumps etc.



8132

New base can be used with:



8130

Operative flange for CP1
common rail pumps
to be applied on our art 8132

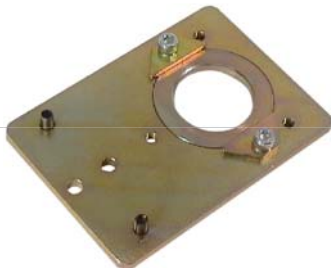

9669

Operative flange for DPS pumps
to be applied on our art 8132

Pump clamping flanges



9680-A

BH 1 688 010 124

Clamping bracket
on test bench



9601

BH 0 986 611 358

Clamping bracket
on **9260**



9356-A

Clamping bracket
on **8132**



Test bench flange for PES...A pumps
(on FIAT)

9478-B

BH 1 685 720 017

Test bench flange for PES...P-PV pumps
with \varnothing 95 hole

9478-C

BH 1 685 720 060

Test bench flange for PES...P pumps
(IVECO 190.26)
with \varnothing 107 hole

9479-D

BH 1 685 720 159

Test bench flange for PES... MW pumps
(MERCEDES, VOLVO etc.)
with \varnothing 68 hole

9478-A

BH 1 685 720 018

Test bench flange for EP/VA.. VE.. CAV pumps
with \varnothing 50 hole

9478

BH 1 685 720 062

Test bench flange for DPS pumps
with \varnothing 68 hole

9478-E

BH 1 685 720 219

Test bench flange for VP44-VR30 pumps

8123

Test bench flange for VP44 pumps

9478-T

Test bench flange for CATERPILLAR pumps SLIV series
with \varnothing 95 hole

9478-F

Test bench flange for pumps mounted on
RENAULT MEGANE

9478-M

Test bench flange for pumps mounted on
MERCEDES

9746

BH 1 685 720 208



MARBED[®]
PROFESSIONAL DIESEL SERVICE TOOLS

9659

Cushioned Coupling for CAV-DPA-DPS- DPC-BOSCH VE



9659

Cushioned puller coupling
for CAV DPA, DPS, DPC
and BOSCH VE pumps
adaptable to all test benches by **9680-A (A)**
supplied with 3 gears



9659-I17

gear - cone Ø 17



9659-I20

gear - cone Ø 20



9659-IDPA

CAV female gear - external Ø gear 35,5



optional

9872

CAV gear
NOT INCLUDED



MARBED[®]
PROFESSIONAL DIESEL SERVICE TOOLS

9662



9662 - TOOL BOX FOR CAV-DPA ROTARY PUMPS

9662

Complete tool box for assembly and disassembly
of CAV-DPA rotary pumps with mechanical and
hydraulic governor
30 items, 60 particulars

9662

Tools for CAV-DPA rotary pumps

9573	1	Graduated device
9211	1	Drive plate srew
9656	1	Manometer for pump feed pressure
9565	1	Roller distance gauge on control plate
9555-A	1	Wrench for cam pin
9100	1	Connector for diesel oil inlet
9100-A	1	Connector for diesel oil inlet
9652	1	Connector
9567	1	Polygonal wrench
9651	1	Spanner transfer pump rotor
9097	6	Pressure connector
9650	1	Drive shaft holding tool
9649	1	Spanner drive plate
9272-A	1	Governor counter weight balancer
9274	1	Bush for oil seal assembly

Pezzi



Kit composed by 9 OR guard bushes	1	9663
Assembly bush for governor cap	1	9275
Assembly rod for metering valve	1	9276
Governing wrench	1	9277
Sleeve puller	1	9278
Oil seal puller	1	9279
Alignement tool, hydraulic head	1	9282
Alignement tool	1	9283
Torque adaptor	1	9284
Reduction union	1	9290
Reduction union	1	9291
Reduction	1	9285
Drilled union	3	9292
Blind cap	1	9293
Blind cap	1	9294
	Pezzi	

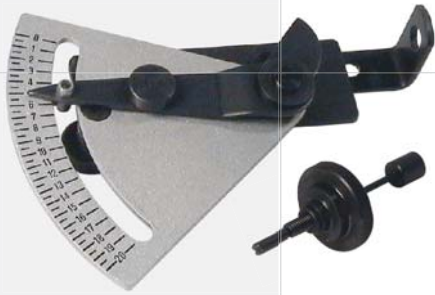

9573
Gauge auto advance
with feeler pin assembly (*our art 9647*)
CAV 7244-59
CAV 7244-70



9211
Torque adaptor,
drive plate screws
CAV 7244-482
CAV 7244-404



9656
0-16 manometer for feeding pressure pump



9565
Roller distance gauge on control plate
with air pressure
CAV 7144-262

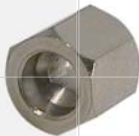

9555-A
Wrench for cam ring pin
CAV 7244-125 B



9100
Diesel oil inlet union
14 x 1,5 - 1/2"



9100-A
Diesel oil inlet union
14 x 1,5 - 7/16"



9652
Manometric reduction union
to set the internal pressure
14 x 1,5 - 8 x 1
CAV 7244-892



9567
1/4" polygonal wrench for cap screws



9651
Spanner transfer pump rotor *CAV 7244-889*



9097
Extended pressure union
for bench testing
12 x 1,5 - 11"



9650
Drive shaft holding tool *CAV 7244-773*



9649
Spanner drive plate *CAV 7244-744*

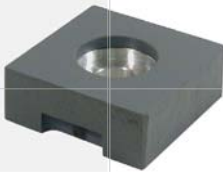

9272-A
Governor counter weight balancer



9274
Bush for oil seal assembly *CAV 7144-260 A*



Kit with 9 OR guard bushes

9663-A	<i>Ø 6,5 - 29 mm</i>
9663-B	<i>Ø 10,5 - 44 mm</i>
9663-C	<i>Ø 12,5 - 38 mm</i>
9663-D	<i>Ø 13 - 23,5 mm</i>
9663-E	<i>Ø 15 - 47 mm</i>
9663-F	<i>Ø 16,5 - 44 mm</i>
9663-G	<i>Ø 20 - 42 mm</i>
9663-H	<i>Ø 23,2 - 26,5 mm</i>
9663-I	<i>Ø 24,5 - 80 mm</i>



9275
Assembly bush for governor cap



9276
Assembly rod for metering valve *CAV 7044-895*



9277
 Governing wrench for squirt feed pressure
14 x 1,5 - 3/32" **CAV 7244-571**



9278
 Sleeve puller **CAV 7144-875**



9279
 Oil seal puller **CAV 7244-334**



9282
 Alignment tool, hydraulic head **CAV 7144-508 B**



9283
 Alignment tool, oversize hydraulic head **CAV 7144-508 C**



9284
 Torque adaptor 8 mm drive shaft screw **CAV 7144-261**



9290
 Reduction for wrench 9277
14 x 1,5 - 7/16"



9291
 Reduction for wrench 9277
14 x 1,5 - 1/2"



9285
 Reduction
M 12 x 1,5 - F 12 x 1,5



9292
 Drilled union
14 x 1,5



9293
 Blind cap
7/16"



9294
 Blind cap
1/2"



MARBED[®]
PROFESSIONAL DIESEL SERVICE TOOLS

9210-S



9210-S - TOOL BOX FOR CAV ROTARY PUMPS

9210-S

Tool box for assembly and disassembly
of CAV rotary pumps
16 items, 23 particulars

9210-S

Tools for CAV rotary pumps



9573	1	Graduated device
9211	1	Drive plate srew
9272	1	Governor counter weight balancer
9029	1	Toothed coupling for pump motoring over
9555	1	Governing wrench
9100	1	Connector for diesel oil inlet
9100-A	1	Connector for diesel oil inlet
9652	1	Connector
9675-A	1	Connector
9651	1	Spanner transfer pump rotor
9097	6	Pressure connector
9650	1	Drive shaft holding tool
9649	1	Spanner drive plate
9273	1	Puller hook
9653	1	Wrench
9654	1	Wrench

Pieces

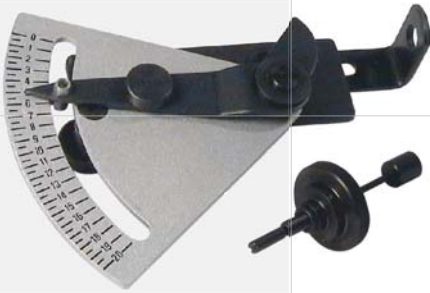

9573
Gauge auto advance
with feeler pin assembly (*our art 9647*)
CAV 7244-59
CAV 7244-70



9211
Torque adaptor,
drive plate screws
CAV 7244-482
CAV 7244-404



9272
Governor counter weight balancer



9029
Toothed motoring coupling
ex Marbed 9900



9555
Socket inserter torque spanner
cam advance
CAV 7244-125 B



9100
Diesel oil inlet union
14 x 1,5 - 1/2"



9100-A
Diesel oil inlet union
14 x 1,5 - 7/16'



9652
Manometric reduction union
to set the internal pressure
14 x 1,5 - 8 x 1
CAV 7244-892



9675-A

Manometric reduction union
to set the internal pressure
14 x 1,5 - 8 x 1



9651

Spanner transfer pump rotor

CAV 7244-889



9097

Extended pressure union
for bench testing
12 x 1,5 - 11"



9650

Drive shaft holding tool

CAV 7244-773



9649

Spanner drive plate

CAV 7244-744



9273

Removal hook

CAV 7244-408



9653

Socket wrench
5/16"



9654

Socket wrench
3/32"



MARBED[®]
PROFESSIONAL DIESEL SERVICE TOOLS

9731-B



9731-B - TOOL BOX FOR CAV-DPS PUMPS

9731-B

Complete tool box for assembly and disassembly
of CAV-DPS pumps
(FORD T. I.D. - F. YORK - WV GOLF)
31 items, 51 particulars

9731-B

Tools for CAV-DPS pumps

9664-B	1	Auto advance gauge
9288	1	Gauge
9303	1	Adaptor
9304	1	Pressure measuring kit
9667	1	OR bush
9305	1	Bolla a Timing disk bubble
9570	1	Wrench
9290	1	Reduction union
9291	1	Reduction union
9570-A	1	Wrench
9761-A7	1	Torx T25
9306	1	Torx T20
9310	1	Torx T15
9316	1	Torx T10
9674	1	Timing retainer
		Pezzi



Dial gauge bearing	1	9761-A8
Inserter	1	9671
Toothed wrench	1	9329
Toothed wrench	1	9728
Oil seal guide	1	9330
Timing pin	1	9782
Operative plate	1	9669
Coupling	1	9865
Puller	1	9866
Inserter	1	9332
DPS adjusting wrench	1	9855
DPS adjusting wrench	1	9856
Spring adjusting wrench	1	9859
Spring adjusting wrench	1	9860
Accelerator lever survey	1	9572
FORD TRANSIT modification	1	9572-A
Pezzi		



Auto advance device for DPS pumps
(10 pieces)

9664-B

CAV 7244-447
CAV 7244-572
CAV 7244-435

A CAV 7244-572 Gauge for YORK - FORD TRANSIT
B CAV 7244-435 Set of 8 gauges (A-H)



Internal pressure gauge
0 - 2,5 BAR
with bumper glicerol

9288

CAV 7244-275 A



Transfer pressure adapter

9303

CAV 7244-275 A

Gauge kit for DPS pumps

9304

CAV 7144-262

Bush couple - for advance shaft OR
mm 6,2 x 30
and for extra shaft
mm 7,2 x 25

9667

CAV 7244-441
CAV 7244-442



Timing disk bubble

9305

ARD 20/1



Adjusting wrench
3/32" - union 14 x 1,5

9570

CAV 7244-571



Reduction union
14 x 1,5 - 7/16"

9290



Reduction union
14 x 1,5 - 1/2"

9291

		<p style="text-align: right;">9570-A CAV 7244-410 A</p>
	<p>Adjusting wrench 3/32" union 12 x 1,5</p>	
	<p>TORX T25 wrench with 1,5 mm hole</p>	<p style="text-align: right;">9761-A7 CAV 7244-437</p>
	<p>TORX T20 wrench</p>	<p style="text-align: right;">9306 CAV 7244-438</p>
	<p>TORX T25 wrench</p>	<p style="text-align: right;">9310 CAV 7244-439</p>
	<p>TORX T10 wrench</p>	<p style="text-align: right;">9316 CAV 7144-439 A</p>
	<p>Timing lock for CAV-DPS pumps</p>	<p style="text-align: right;">9674 CAV 7244-448</p>
	<p>Comparator bearing in 4 pieces for the timing of CAV-DPS pumps and without reduction for BOSCH EP...VE pumps</p>	<p style="text-align: right;">9761-A8</p>
	<p>oil seal inserter DPS pump drive shaft Ø 17</p>	<p style="text-align: right;">9671 CAV 7244-445 CAV 7244-445 A</p>
	<p>Toothed wrench 1/2" for CAV-DPS pump cam screw (FORD TRANSIT)</p>	<p style="text-align: right;">9329 CAV 7244-573</p>
	<p>Toothed wrench couple control for DPS pump (FORD TRANSIT)</p>	<p style="text-align: right;">9728</p>
	<p>Oil seal guide</p>	<p style="text-align: right;">9330 CAV 7244-485</p>
	<p>Time holding pins (FORD TRANSIT D.I.)</p>	<p style="text-align: right;">9782</p>

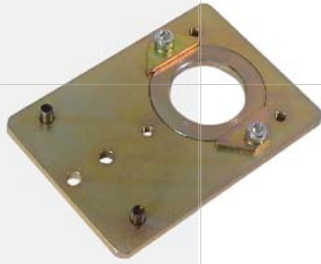

9669
 Operative plate for CAV-DPS
mm 68
 and adaptor ring for DPC pumps
mm 50

9669
 CAV 1804-411
 CAV 1804-410



9865
 3 holes coupling for DPS pumps, direct injection

9865
 ADC 160



9866
 Motoring hub puller
 $\varnothing 74$
 To be used with pneumatic gun

9866



9332
 Nylon oil seal inserter
 $\varnothing 20$

9332
 V 706
 V 612/B



9855
 LDA adjusting wrench on CAV-DPS Turbo

9855
 CAV 7244-586



9856
 LDA adjusting wrench on CAV-DPS Turbo

9856
 CAV 7244-584



9859
 Spring LDA adjusting wrench on CAV-DPS Turbo

9859
 CAV 7244-582



9860
 Spring LDA adjusting wrench on CAV-DPS Turbo

9860
 CAV 7244-581

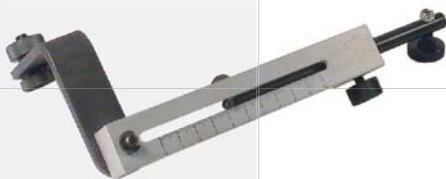

9572
 Graduated checking to survey the total
 travel of the CAV-DPS pumps accelerator lever

9572
 CAV 7244-411



9572-A
 Modification for 9572 to survey the travel from
 the position of the antistopping screw to the
 maximum screw on CAV-DPS (ex.: FORD TRANSIT)

9572-A
 CAV 7244-583



MARBED[®]
PROFESSIONAL DIESEL SERVICE TOOLS

9731-C



9731-C - TOOL BOX FOR CAV-DPC PUMPS

9731-C

Tool box for assembly, disassembly
and timing of CAV-DPC pumps
17 articles - 23 particulars

9731-C

Tool box for CAV-DPC pumps



9664-C	1	Advance gauge
9670	1	Stopping lever adjuster
9671-A	1	Oil seal inserter
9673	1	Adjusting wrench
9672	1	Wrench
9675	1	Manometric reduction
9666	1	Slot wrench
9295	1	Wrench
9676	1	Wrench
9678	1	Wrench
9339	1	Hydraulic head support
9341	1	Kit for manometer
9837-A	1	3 plug assembly
9842	1	External ring puller
9832	1	Internal ring puller
9344	1	Internal pressure union
9362	1	Bush puller



Advance gauge for CAV-DPC pumps **9664-C**
CAV 1804-811



Stopping lever adjuster for CAV-DPC pumps **9670**
CAV 7144-559A



Oil seal inserter for pump drive shaft **9671-A**



Adjusting wrench with guide **9673**
CAV 1804-444
 4,85 mm



Wrench with scale for diesel oil delivery adjusting **9672**
CAV 1804-423



Manometric reduction for transfer pressure **9675**
CAV 1804-442
 thread 8 x 1,25



Slot wrench for auto advance nut 1/2 " **9666**
CAV 1804-401



14 mm hexagonal wrench for diesel oil inlet unions for CAV-DPA-DPC pumps **9295**



8 mm shaped wrench for CAV-DPC pumps **9676**

9678



Wrench for motoring gear
Ø 35,5

9339



Hydraulic head support

CAV 1804-417

9341



Kit for gauge to survey
the internal pressure

9837-A



Three nylon plugs
(our arts. 9837-809-B, 9837-809-D, 9837-809C)
for manual bearing insertion

CAV 1804-809 B

CAV 1804-809 C

CAV 1804-809 D

9842



External ring puller
for CAV-DPC pump bottom

9832



Puller for the bearing internal ring

9344



Union for internal pressure

CAV 1804-447 B

9362



Bush puller

CAV 1804-800



MARBED[®]
PROFESSIONAL DIESEL SERVICE TOOLS

9731-N



9731-N - TOOL BOX FOR LUCAS DPC PUMPS

9731-N

Tool box for LUCAS DPC / NUMERIC pumps
14 articles

9731-N

Tool box for LUCAS DPC pumps



8040	1	Equalizer
8027	1	Adapter
8028	1	Adapter
8029	1	Adapter
8030	1	Timing control pin
8031	1	Timing control pin
8032	1	Advance piston positioner
8033	1	Wrench
9996	1	Wrench
9998	1	Puller
9998-A	1	Coupling
8034	1	Accelerator lever register
8035	1	Wrench
8036	1	Stopper



Equalizer for stroke control **8040**
V638



Adapter **8027**



Adapter **8028**



Adapter **8029**
CAV 1804-611



Timing control pin **8030**
CAV 1804-626



Timing control pin **8031**
CAV 1804-616



Advance piston positioner **8032**
CAV 1804-649



Solenoid wrench

8033



Triangular wrench for pump plug
CAV-DPC (FIAT MAREA, CITROEN)

9996

CAV 1804-624



Motoring hub puller
for DPC - BOSCH VE pumps on
VW POLO 1900, GOLF TD

9998



Coupling for motoring hub with 3 holes
for DPC - BOSCH VE pumps on
VW POLO 1900, GOLF TD

9998-A



Accelerator lever register

8034



Tightening wrench for inspection plastic plug

8035

CAV 1804-625



Roller bearing stopper

8036

CAV 1804-650

9531

24 mm hexagonal wrench for solenoid valve
for CAV DPC and BOSCH VE pumps

9531-A

26 mm wrench for solenoid valve
on CAV DPC NUMERIC

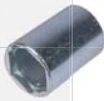
9531-B

27 mm wrench for CAV DPC NUMERIC
pumps advance actuator

9531-C

24 mm wrench for CAV DPC NUMERIC
pumps advance actuator

9996

Triangular 25 mm wrench for
pump plug on CAV DPC NUMERIC pumps

9297

Chiave sagomata 9/16" per
raccordi mandata nafta pompe CAV

9695

5/8" wrench for CAV
pumps delivery unions

9696

9/16" wrench for CAV
pumps delivery unions

9677

3/16" wrench for CAV DPA shaft nut

9676

8 mm shaped wrench
for CAV DPC-DPS pumps

9295

14 mm wrench for diesel oil inlet unions
for CAV DPA DPC pumps



9408

Motoring coupling for Ø 17 gear
CAV DPA pumps



9029

Motoring coupling for CAV DPA pumps



9650

Fixing gear wrench Ø 17



9872

CAV pumps gear

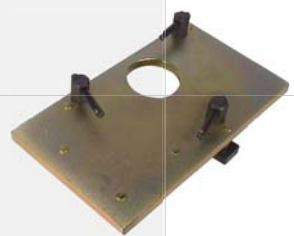

9213

Operative plate to fix to the vice
CAV DPA DPC pumps
Ø 48 and Ø 50



9296

Elastic rings puller for CAV pumps



9657

Angular pipe for vacuum gauge and gauge
3/8 gas connection



9302

0/76 mm Hg vacuum gauge



9658

Angular pipe for vacuum gauge and gauge
3/8 gas connection



9568

Fixing cap wrench 1/4"



9568-A

Polygonal wrench
3/8" - 7/16"



9648

Tweezers

CAV 7244-277



9665

Assembly composed by 16 pieces
to survey the internal pressure
of CAV DPA-DPC-DPS pumps



9647-A

Long feeler pin assembly



9566

Toothed wrench for hexagonal nuts
to fix diesel oil inlet unions
used for CAV pumps

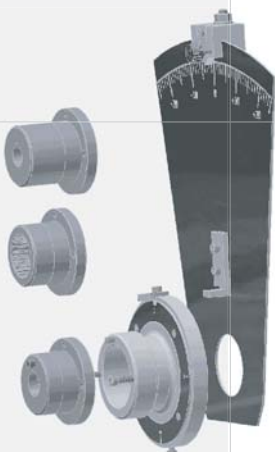

9668

360° goniometric disk for the timing of
CAV DPA, DPC, DPS pumps equipped with

1 *Insert to time CAV DPA, DPC, DPS pumps*

2 *Reduction rings*

1 *Checking plate for CAV DPC timing with indicator shaft
(to connect with the diesel oil inlet union)*



MARBED[®]
PROFESSIONAL DIESEL SERVICE TOOLS

9731-DP



9731-DP - TOOL BOX FOR LUCAS DP200 PUMPS

9731-DP









Tool box for LUCAS DP200 pumps
15 articles

9731-DP

Tool box for LUCAS DP200 pumps



8058	1	Adjusting wrench
8059	1	Adjusting wrench
8060	1	Connector
8061	1	Reduction
8062	1	Reduction
8063	1	Wrench
8064	1	Wrench
8065	1	Puller
8066	1	Reduction plate
8067	1	Wrench
8068	1	Puller
8069	1	Wrench
8070	1	Wrench
8041	1	Reductions kit
8042-A	1	Connectors kit

		8058
	<p>Adjusting wrench 14 x 1,5 - 3 screws</p>	8059
	<p>Adjusting wrench 12 x 1,5 - 3 screws</p>	8060
	<p>Connector</p>	8061
	<p>Reduction</p>	8062
	<p>Reduction for electronic degrees tester</p>	8063
	<p>Toothed bash wrench</p>	8064
	<p>Toothed bash wrench</p>	8065
	<p>Puller</p>	8066

Reduction plate for mounting the disk to the cone shaft 17 and 20 with rigging

CAV 7244-578



Wrench **8067**
CAV 6408-78



Puller **8068**



Wrench for head screw **8069**



Wrench for head **8070**
CAV 7144-939



Reductions kit for degrees tester **8041**
9 pieces



Connectors kit **8042-A**
16 pieces

22 x 14,5 - 30 x 15 - 38 x 15 h.7 -
38 x 15 h.4 - 45 x 17 35 x 20 h.2 -
43 x 19 - 50 x 16,5 - 45 x 16,8 -
56 x 16,8 - 65 x 15 - 60 x 11 -
40 x 11 - 46 x 24 h.6,5 -
46 x 24 h-10 - 62 x 21

Tools for LUCAS Epic pumps



8118

Ejector of LUCAS EPIC 2nd serie
pumps on MERCEDES C 220



9760-A

Bolt with spring \varnothing 6,5 mm
for EPIC 70 pumps phasing
on MERCEDES

Tools for DENSO pumps



8093
Tappet-presser with rotating pilot
In-line Nippondenso 6 cyl. on VOLVO

8093
DENSO 10700



8094
Terminal assembly/disassembly valve group
In-line Nippondenso 6 cyl. on VOLVO

8094
DENSO 10680

Advance gauge

9664-N

The universal body 9664-N can be applied on 5 different types of pumps, depending of the installed interface

9664-F

Interface for DPS pumps

9664-D

Interface for DPC pumps

9664-E

Interface for DP200 pumps

9664-H

Interface for VE pumps

9664-S

Interface for DENSO pumps

9334

Transparent body, spare part of 9664-N



9664-B

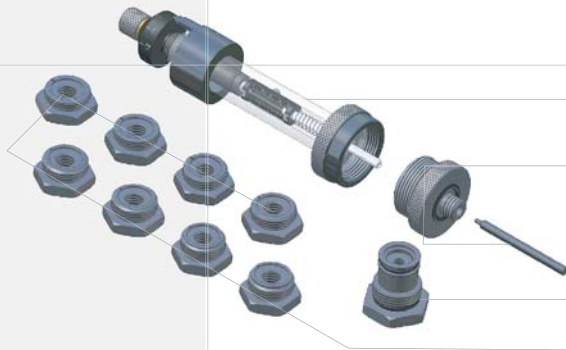

Body **9664-N**

Interface for DPS pumps **9664-F**

Gauge for FORD TRANSIT **1/B**

Set of 8 gauges **1/A**

9664-C

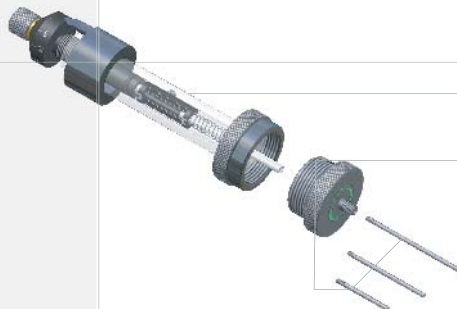

Body **9664-N**

Interface for DPC pumps **9664-D**

9664-DP

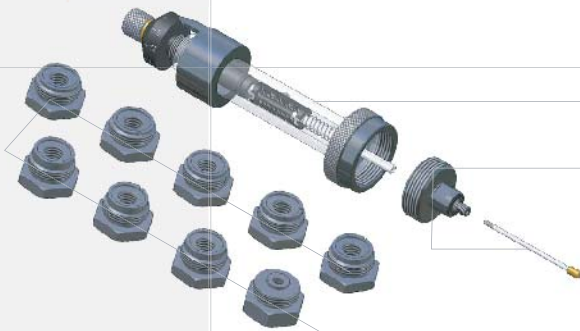

Body **9664-N**

Interface for DP200 pumps **9664-F**

Set of 9 gauges **8041**

9664-VE

Repalce **9471-01** - Up to 20 BAR

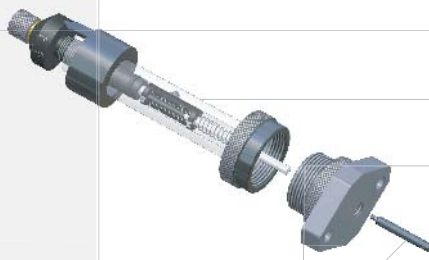

Body **9664-N**

Interface for VE pumps **9664-H**

9664-ND

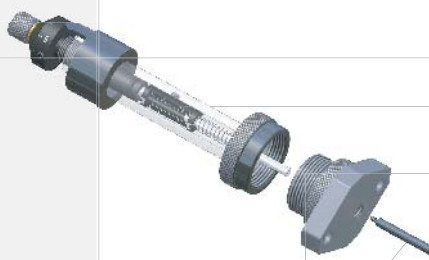

Body **9664-N**

Interface for DENSO pumps **9664-S**



MARBED[®]
PROFESSIONAL DIESEL SERVICE TOOLS

9761-A



9761-A - COMPARATOR BEARING BOX FOR ROTARY PUMPS

9761-A

Comparator bearing box for
rotative pumps BOSCH EP...VA...VE,
CAV DPA, DPC, DPS
12 items, 23 pieces

9761-A

Comparator bearings for rotary pumps



9733-A	1	Comparator
9861	1	Comparator bearing
9761-A1	1	Timing pin
9186-N	1	Comparator bearing - not sold alone
9761-A2	1	Comparator bearing
9761-A3	1	Nut
9761-A4	6	Nut couple
9761-A5	1	Reduction
9761-A6	1	Comparator bearing
9674	1	Timing lock
9761-A7	1	Torx wrench
9761-A8	1	Comparator bearing



9733-A

Centesimal comparator 5 mm
with back connection (B)



9861

Comparator bearing for BOSCH VA pumps

1804-606
1804-607
1804-600



9761-A1

Timing pin on ROTO DIESEL

1084-761



9186-N

Comparator bearing BOSCH EP/VA...B pumps
thread 12x1
with shaft 25 mm Ø 2 thread 2,5 (our art **15-D4**)

NOT SOLD
ALONE

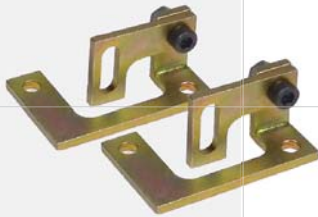

9761-A2

Couple of dial indicator for
ROTO DIESEL pumps

1084-767



9761-A3

Fixing nut for flange comparator

1084-764



9761-A4

Nut couple to fix to the pump
the comparator bearing (ns art. **9761-A2**)

1084-766

9761-A5

Comparator reduction from 3 mm to 2,5 mm

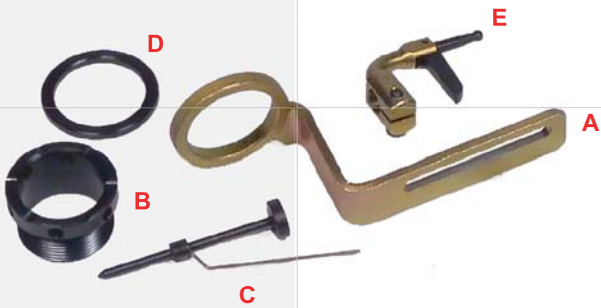
9761-A6

Comparator bearing for timing searching on CAV-DPC (5 pieces)

A	9761-B	1804-486	<i>Angle bracket</i>
B	9761-C	1804-487	<i>Union</i>
C	9761-D	1804-488/A	<i>Push rod with guide (54mm)</i>
D	9761-E	1804-489	<i>Distance ring</i>
E	9761-F	1804-491	<i>Equalizer comparator bearing</i>

9674

Timing lock for CAV-DPS pumps

CAV 7244-448

9761-A7

TORX T25 wrench con with 1,5 mm hole for DPS pumps

CAV 7244-437

9761-A8

Comparator bearing composed by 4 pieces for the timing of CAV-DPS pumps and without reduction for the timing of BOSCH EP...VE pumps

 CAV 7244-448
 KDEP 1085



9761 - COMPARATOR BEARING BOX FOR CAV ROTARY PUMPS

9761

Comparator bearing box for
rotative pumps CAV DPC, DPS

9733-A	1	Comparator
9761-A3	1	Nut
9761-A6	1	Comparator bearing
9674	1	Timing lock
9761-A7	1	Torx wrench
9306	1	Torx wrench
9310	1	Torx wrench
9316	1	Torx wrench

Pieces



9733-A

 Centesimal comparator 5 mm
 with back connection (B)

9761-A3

Fixing nut for flange comparator

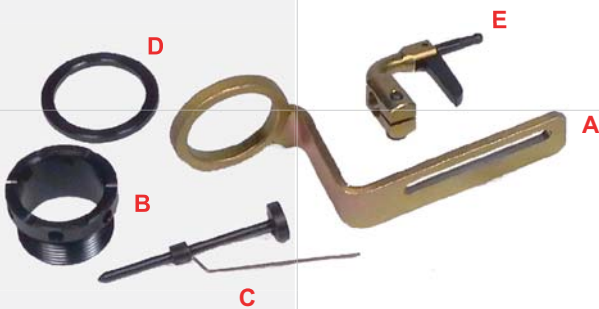
1084-764

9761-A6

 Comparator bearing for timing searching
 on CAV-DPC (5 pieces)

A	9761-B	1804-486	<i>Angle bracket</i>
B	9761-C	1804-487	<i>Union</i>
C	9761-D	1804-488/A	<i>Push rod with guide (54mm)</i>
D	9761-E	1804-489	<i>Distance ring</i>
E	9761-F	1804-491	<i>Equalizer comparator bearing</i>

9674

Timing lock for CAV-DPS pumps

CAV 7244-448

9761-A7

 TORX T25 wrench con with 1,5 mm hole
 for DPS pumps

CAV 7244-437

9306

TORX T20 wrench

CAV 7244-438

9310

TORX T25 wrench

CAV 7244-439

9316

TORX T10 wrench

CAV 7144-439 A



www.marbed.com

MARBED Srl - Piazza Novelli, 4 - 20129 Milano - Italy

I. +39 02.71.49.84 - Fax +39 02.70.10.26.67

e-mail info@marbed.com