



**MARBED**<sup>®</sup>  
PROFESSIONAL DIESEL SERVICE TOOLS

# 221



**MARBED**<sup>®</sup>  
PROFESSIONAL DIESEL SERVICE TOOLS

---

catalog

## **BH distributor injection pumps**

Version 02 - 01-2008 - COPYRIGHT MARBED Srl 2007 all rights reserved

MARBED  
CATALOG

**BH distributor i. pumps**

**221**



***[www.marbed.com](http://www.marbed.com)***

---

MARBED Srl - Piazza Novelli, 4 - 20129 Milano - Italy

I. +39 02.71.49.84 - Fax +39 02.70.10.26.67

e-mail [info@marbed.com](mailto:info@marbed.com)



**MARBED**<sup>®</sup>  
PROFESSIONAL DIESEL SERVICE TOOLS

# 9356-A

Swivel vice  
for flanges BOSCH  
PES..A, VE, VA pumps



**9356-A**

Swivel vice for operative flanges  
of PES...A, VE, VA pumps etc.



**8132**

New base can be used with:



**8130**

Operative flange for CP1  
common rail pumps  
*to be applied on our art 8132*

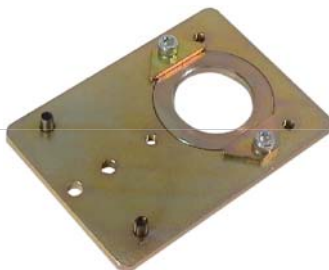

**9669**

Operative flange for DPS pumps  
*to be applied on our art 8132*

# Pump clamping flanges



**9680-A**

*BH 1 688 010 124*

Clamping bracket  
on test bench



**9601**

*BH 0 986 611 358*

Clamping bracket  
on **9260**



**9356-A**

Clamping bracket  
on **8132**



Test bench flange for PES...A pumps  
(on FIAT)

**9478-B**

*BH 1 685 720 017*

Test bench flange for PES...P-PV pumps  
with  $\varnothing$  95 hole

**9478-C**

*BH 1 685 720 060*

Test bench flange for PES...P pumps  
(IVECO 190.26)  
with  $\varnothing$  107 hole

**9479-D**

*BH 1 685 720 159*

Test bench flange for PES... MW pumps  
(MERCEDES, VOLVO etc.)  
with  $\varnothing$  68 hole

**9478-A**

*BH 1 685 720 018*

Test bench flange for EP/VA.. VE.. CAV pumps  
with  $\varnothing$  50 hole

**9478**

*BH 1 685 720 062*

Test bench flange for DPS pumps  
with  $\varnothing$  68 hole

**9478-E**

*BH 1 685 720 219*

Test bench flange for VP44-VR30 pumps

**8123**

Test bench flange for VP44 pumps

**9478-T**

Test bench flange for CATERPILLAR pumps SLIV series  
with  $\varnothing$  95 hole

**9478-F**

Test bench flange for pumps mounted on  
RENAULT MEGANE

**9478-M**

Test bench flange for pumps mounted on  
MERCEDES

**9746**

*BH 1 685 720 208*



**MARBED**<sup>®</sup>  
PROFESSIONAL DIESEL SERVICE TOOLS

# 9300-B



9300-B - TOOL BOX FOR EP/VA...B...C BOSCH PUMPS

## 9300-B

Tool box for EP/VA...B...C BOSCH pumps  
equipped with 11 pieces

<b>9208</b>	1	Plug
<b>9209</b>	1	Plate and bolt for 9208
<b>9190</b>	1	Bush for the housing of rotor runner
<b>9471-2</b>	1	Wrench for metering valve
<b>9207</b>	1	Toothed wrench for control lever
<b>9346</b>	1	Aluminium shim for 9180
<b>9183</b>	1	Reduction for 9180
<b>9181</b>	1	Adapter shaft
<b>9182</b>	1	Reduction for 9180
<b>9180</b>	1	Graduated device
<b>9471-8</b>	1	Bush for roll bearing ring housing
<b>9204</b>	1	Adjusting wrench for pressure governing valve

Pieces

		<b>9208</b> KDEP 1097 BH 0 986 611 780
	Plate and bolt for 9208	<b>9209</b> KDEP 1097 BH 0 986 611 780
	Cap for the housing of the timing system rotor runner <i>inside Ø 46 mm</i>	<b>9190</b> KDEP 1101 BH 0 986 611 791
	Dial gauge bearing for rod stroke thread 24x1,5 protrusion 18 mm for pe...p pumps (clamp included - <i>our art. 9502-a</i> )	<b>9471-2</b> KDEP 1086 BH 0 986 611 757
	Pumping group disassembly clamp	<b>9207</b> KDEP 1091 BH 0 986 611 765
	Shim for 9180 graduated device <i>h 20 mm</i>	<b>9346</b>
	Threaded union for 9180 graduated device EP/VM <i>26x1,5 - only reduction</i>	<b>9183</b> BH 1 688 130 054
	Adapter shaft on 9180 graduated device for EP/VA...B	<b>9181</b> BH 1 688 130 400
	Threaded union for 9180 graduated device EP/VA...B...C <i>28x1,5 - only reduction</i>	<b>9182</b> BH 1 688 130 300
	Graduated device to test the automatic advance on BOSCH EP/VA...B...C pumps <i>Equipped with extended pin</i>	<b>9180</b> BH 1 688 130 121
	Cap for roller bearing ring housing	<b>9471-8</b> KDEP 1100 BH 0 986 611 790
	Adjusting wrench for pressure governing valve	<b>9204</b> KDEP 1092 BH 0 986 611 766





**MARBED**<sup>®</sup>  
PROFESSIONAL DIESEL SERVICE TOOLS

# 9471-K



9471-K - TOOL BOX FOR BOSCH EP-VE PUMPS

## 9471-K

Complete tool box for EP-VE BOSCH pumps  
equipped with 60 pieces

# 9471-K

## Tools for BOSCH EP-VE pumps

<b>9664-VE</b>	1	Graduated device
<b>9471-2</b>	1	Governing pressure wrench
<b>9471-5</b>	1	Triangular wrench
<b>9471-6</b>	1	Triangular wrench
<b>9471-9</b>	1	Dial gauge bearing
<b>9471-11</b>	1	"MS" level spacer
<b>9471-13</b>	1	9184 spacer reduction
<b>9471-14</b>	1	Dial gauge bearing
<b>9471-15</b>	1	Shaft toothed wrench
<b>9553</b>	1	Dynamometric wrench reduction
<b>9188</b>	1	Bush puller
<b>9184</b>	1	Measure device
<b>9185</b>	1	9184 spacer reduction
<b>9301</b>	1	9184 spacer reduction
<b>9301-A</b>	1	9184 spacer reduction
<b>9186</b>	1	Dial gauge bearing with rod
<b>9204</b>	1	Adjusting wrench
<b>9471-8</b>	1	Cap for roll bearing ring
<b>9190</b>	1	Cap timing system rotor runner
<b>9471-7</b>	1	Cap timing system rotor runner
<b>9262</b>	1	Shaft bush kit
<b>9261</b>	1	Aluminium fenders
<b>9189</b>	1	Tool to survey the EP-VA slider level
<b>9195</b>	1	Gauged ring for 9189
<b>9194</b>	1	Piston spring spacer
<b>9281</b>	1	Positioning gauge

Pieces





Valve jig	1	<b>9280</b>
Governor and electromagnet jig	1	<b>9412</b>
Oil seal connector	1	<b>9411</b>
Elastic bush inserter	1	<b>9471-3</b>
Threaded puller	1	<b>9197</b>
Bush connector	1	<b>9196</b>
Roll puller	1	<b>9202</b>
Male-Female reduction	1	<b>9471-4</b>
Male-Female reduction	1	<b>9471-16</b>
Male reduction	1	<b>9199</b>
Double bolt	1	<b>9200</b>
Hook for "OR" removing	1	<b>9201</b>
Screwdriver for tors screws	1	<b>9610</b>
Socket screwdriver	1	<b>9607</b>
Jig to connect the control levers	1	<b>9556</b>
Jig for the spacers bush seals	1	<b>9518</b>
Puller inserter for bushings	1	<b>9833</b>
Stopping lever jig	1	<b>9471-12</b>
Self-threading puller for oil seal	1	<b>9586</b>
End float tool	1	<b>9625</b>
Dial gauge bearing	1	<b>9247</b>
Surveying gauge for cam shaft	1	<b>9628</b>
Shaft extended toothed wrench	1	<b>9471-15A</b>
Shaft hexagonal wrench	1	<b>9471-15B</b>
Nylon plug for oil seal puller	1	<b>9837-B</b>
Nylon plug for oil seal inserter	1	<b>9837-C</b>

Pieces



Graduated device to test the automatic advance  
EP/VE BOSCH pumps reinforced

**9664-VE**
*BH 1 688 130 240*

Governing pressure wrench

**9471-2**
*KDEP 1086  
BH 0 986 611 757*

Triangular wrench for central closing plug

**9471-5**
*KDEP 1080  
BH 0 986 611 750*

Triangular wrench for bearing screws  
governing lever

**9471-6**
*KDEP 1087  
BH 0 986 611 758*

Dial gauge bearing with rods

**9471-9**
*KDEP 1085  
BH 1 680 110 630*

Spacer to adjust the sleeve  
starting travel "MS" level

**9471-11**
*KDEP 1084  
BH 0 986 611 753*

Spacer reduction for our art. 9184

**9471-13**
*KDEP 2931/3  
BH 1 683 458 150*

Dial gauge bearing to zero the dial gauge

**9471-14**
*KDEP 1032*

Toothed wrench to fix  
and adjust the governor shaft

**9471-15**
*KDEP 1082  
BH 0 986 611 751*

Dynamometric wrench reduction  
with 1/2" double square

**9553**
*KDEP 2921  
BH 0 986 611 275*



Bush puller for the pressure governing valve  
and bush device of the automatic supplement

**9188**

*KDEP 1027*  
*BH 0 986 611 562*



Measure device (with comparator) for  
the delivering start governing  
12x1mm

**9184**

*BH 1 688 230 045*



Spacer reduction for our art. 9184  
13,5x2 mm

**9185**

*KDEP 2931/2*  
*BH 1 683 391 150*



Spacer reduction for our art. 9184  
12x1 mm

**9301**

*KDEP 2931/1*  
*BH 1 683 391 114*



Spacer reduction for our art. 9184  
12,5x1 mm

**9301-A**

*BH 1 683 391 125*



Dial gauge bearing for the delivery start  
12x1 mm  
with rod

**9186**

*KDEP 2940*



Adjusting wrench  
for pressure governing valve

**9204**

*KDEP 1092*  
*BH 0 986 611 766*



Cap for roll bearing ring housing

**9471-8**

*KDEP 1100*  
*BH 0 986 611 790*



Cap for the housing of the timing system  
rotor runner  
inside Ø mm 46

**9190**

*KDEP 1101*  
*BH 0 986 611 791*



Cap for the housing of the timing system  
rotor runner  
inside Ø mm 42

**9471-7**



Bush kit to dismount the Seeger ring  
on the motoring shaft

**9262**  
*KDEP 1098*  
*BH 0 986 611 785*



Aluminium fenders

**9261**



Tool to survey EP/VA slider level

**9189**  
*KDEP 2934*



Gauger ring for 9189

**9195**



Spacer to adjust the preloading  
of the piston spring

**9194**  
*KDEP 2935*  
*BH 0 986 611 289*



Positioning gauge

**9281**  
*KDEP 1099*  
*BH 0 986 611 789*



Jig to press the closing cap  
of the spheric valve

**9280**  
*KDEP 1094*  
*BH 0 986 611 772*



Jig to measure the spring preloading  
of the governor and electromagnetic

**9412**  
*KDEP 1095*  
*BH 0 986 611 775*



Oil seal connector on Ø 17 shaft

**9411**  
*KDEP 2939*  
*BH 0 986 611 293*



Elastic bush inserter on  
the pressure governing valve

**9471-3**  
*KDEP 1093*  
*BH 0 986 611 769*



Threaded puller  
*mm 5x0,8*

**9197**

	Bush connector	<b>9196</b>
	Roll puller	<b>9202</b>
	Reduction male 12x1,5 - female 12x1,5	<b>9471-4</b>
	Reduction male 12x1,5 - female 14x1,5	<b>9471-16</b>
	Reduction male 12x1,5 - 10x1	<b>9199</b>
	Double bolt 12x1,5	<b>9200</b>
	Hook for "OR" extraction	<b>9201</b> <i>KDEP 2938</i> <i>BH 0 986 611 292</i>
	Screwdriver for TORX T30 screw	<b>9610</b>
	Spheroidal screwdriver to operate until 45°	<b>9607</b>
	Jig to connect the control levers	<b>9556</b> <i>KDEP 1106</i> <i>BH 0 986 611 803</i>
	Jig for spacer bush seal	<b>9518</b> <i>KDEP 1106</i> <i>BH 0 986 611 800</i>



**9833**  
KDEP 1132  
Puller inserter for bushings  
(in 4 pieces)



**9471-12**  
KDEP 1130  
Jig to control the action level  
of the stopping lever  
27,7 mm



**9586**  
KDEP 1113  
Self-threading puller for oil seal on Ø 17 shaft



**9625**  
KDEP 2890  
ATool to measure the end float on  
Ø 17 cam shaft



**9247**  
KDEP 1128  
Dial gauge bearing to survey  
the bushing wear on the cam shaft



**9628**  
KDEP 2899  
Surveying gauge for cam shaft  
protrusion Ø 17 and Ø 20



**9471-15A**  
Extended toothed wrench to fix  
the shaft on the governor



**9471-15B**  
Hexagon wrench (14 mm) to fix  
and adjust the governor shaft



**9837-B**  
Nylon plug for oil seal puller



**9837-C**  
Nylon plug for oil seal inserter





**MARBED**<sup>®</sup>  
PROFESSIONAL DIESEL SERVICE TOOLS

# 9471-A



9471-A- TOOL BOX FOR BOSCH EP-VE PUMPS

## 9471-A

Complete tool box for EP-VE BOSCH pumps  
equipped with 20 pieces

# 9471-A

## Tools for BOSCH EP/VE pumps



<b>9664-VE</b>	1	Graduated device
<b>9471-2</b>	1	Governing pressure wrench
<b>9471-5</b>	1	Triangular wrench
<b>9471-6</b>	1	Triangular wrench
<b>9471-9</b>	1	Dial gauge bearing
<b>9471-11</b>	1	"MS" level spacer
<b>9471-13</b>	1	9184 spacer reduction
<b>9471-14</b>	1	Dial gauge bearing
<b>9471-15</b>	1	Shaft toothed wrench
<b>9553</b>	1	Dynamometric wrench reduction
<b>9188</b>	1	Bush puller
<b>9184</b>	1	Measure device
<b>9185</b>	1	9184 spacer reduction
<b>9301</b>	1	9184 spacer reduction
<b>9301-A</b>	1	9184 spacer reduction
	Pieces	



Graduated device to test the automatic advance  
EP/VE BOSCH pumps rinfoced

**9664-VE**

*BH 1 688 130 240*



Governing pressure wrench

**9471-2**

*KDEP 1086*

*BH 0 986 611 757*



Triangular wrench for central closing plug

**9471-5**

*KDEP 1080*

*BH 0 986 611 750*



Triangular wrench for bearing screws  
governing lever

**9471-6**

*KDEP 1087*

*BH 0 986 611 758*



Dial gauge bearing with rods

**9471-9**

*KDEP 1085*

*BH 1 680 110 630*



Spacer to adjust the sleeve  
starting travel "MS" level

**9471-11**

*KDEP 1084*

*BH 0 986 611 753*



Spacer reduction for our art. 9184

**9471-13**

*KDEP 2931/3*

*BH 1 683 458 150*



Dial gauge bearing to zero the dial gauge

**9471-14**

*KDEP 1032*



**9471-15**  
Toothed wrench to fix  
and adjust the governor shaft

**9471-15**  
*KDEP 1082*  
*BH 0 986 611 751*



**9553**  
Dynamometric wrench reduction  
with 1/2" double square

**9553**  
*KDEP 2921*  
*BH 0 986 611 275*



**9188**  
Bush puller for the pressure governing valve  
and bush device of the automatic supplement

**9188**  
*KDEP 1027*  
*BH 0 986 611 562*



**9184**  
Measure device (with comparator) for  
the delivering start governing  
12x1mm

**9184**  
*BH 1 688 230 045*



**9185**  
Spacer reduction for our art. 9184  
13,5x2 mm

**9185**  
*KDEP 2931/2*  
*BH 1 683 391 150*



**9301**  
Spacer reduction for our art. 9184  
12x1 mm

**9301**  
*KDEP 2931/1*  
*BH 1 683 391 114*



**9301-A**  
Spacer reduction for our art. 9184  
12,5x1 mm

**9301-A**  
*BH 1 683 391 125*

# Other tools for BOSCH VE pumps



**9531**

24 mm hexagonal wrench for solenoid valve  
for CAV DPC and BOSCH VE pumps



**9531-A**

26 mm wrench for solenoid valve  
on CAV DPC NUMERIC



**9531-B**

27 mm wrench for CAV DPC NUMERIC  
pumps advance actuator



**9531-C**

24 mm wrench for CAV DPC NUMERIC  
pumps advance actuator



**9996**

Triangular 25 mm wrench for  
pump plug on CAV DPC NUMERIC pumps

*1804-624*



**8097**

Flat drill with counter-rotation slides for drilling  
screws of the DDS electro-valve on BOSCH VE pumps



**9760-B**

Phasing bolt  $\varnothing$  6 mm on  
BOSCH VE pumps on FORD

*KDEP 1150*

*BH 0 986 611 912*

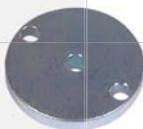

**9760-C**

Phasing spacer for BOSCH VE pumps on FORD

*KDEP 1151*

*BH 0 986 611 913*



**9754-C**

Three-face 8 mm wrench  
for BOSCH VE pumps actuator  
on AUDI, BMW



**9754-D**

Three-face 6,5 mm wrench  
for BOSCH VE pumps actuator  
on AUDI, BMW



**9983**

5-tool kit for extracting ball-plugs  
of BOSCH VE pumps with LDA  
with 10 plugs

**A** *KDEP 1182*

*BH 0 986 611 972*

**C** *KDEP 1184*

*BH 0 986 611 974*

**D** *KDEP 1185*

*BH 0 986 611 975*

**E** *KDEP 1183*

*BH 0 986 611 972*





**9474**

13 mm shaped wrench for  
BOSCH pump clamping nuts on VW GOLF



**9474-A**

13 mm shaped wrench for  
BOSCH pump clamping nuts on VW GOLF



**9383**

19 mm shaped wrench to clamp  
the timing system on AUDI and VOLVO



**9826**

Tool kit for extracting, inserting  
and drill boring bearings of  
Ø 17 shaft on EP/VE pumps  
1/2 mm fixed bore

*KDEP 1170  
BH 0 986 611 946*



**9826-A**

Bare reamer Ø 17



**9828**

Enlarged bearing original Ø 16,5



**9827**

Tool kit for extracting, inserting  
and drill boring bearings of  
Ø 20 shaft on EP/VE pumps  
1/2 mm fixed bore

*KDEP 1171  
BH 0 986 611 953*



**9827-A**

Bare reamer Ø 20



**9829**

Enlarged bearing original Ø 19,5



**9830**

Hand milling cutter for boring gear  
cam seats in EP/VE housing  
maximum bore 0,2  
Operation to be done after replacement  
and boring of VE bushings



	<p>Toothed wrench with 1/2" square to unloose and clamp the threaded ring of the spark lead and idling self-loading adjusting device</p>	<p><b>9558</b>  <i>KDEP 1110</i>  <i>BH 0 986 611 813</i></p>
	<p>Assembly and disassembly tool for the spark lead and idling self-loading adjusting device</p>	<p><b>9559</b>  <i>KDEP 1109</i>  <i>BH 0 986 611 810</i></p>
	<p>Expansion puller for EP/VA...VE pump oil seal</p>	<p><b>9370</b></p>
	<p>Checking set for MS level determination</p>	<p><b>9858</b>  <i>KDEP 1152</i>  <i>BH 0 986 611 914</i></p>
	<p>MS level checking          Fixed lockwire to adjust the sleeve starting stroke on EP/VE pumps with LDA (CITROEN, PEUGEOT, etc.)</p>	<p><b>9858-A</b>  <i>KDEP 1169</i>  <i>BH 0 986 611 945</i></p>
	<p>Puler for the pressure governing valve bush</p>	<p><b>9248</b></p>
	<p>TORX T30 screwdriver for EP/VE pump casing screws</p>	<p><b>9611</b></p>
	<p>T wrench for the pressure governing valve</p>	<p><b>9203</b></p>
	<p>Ground steel bearing for accelerator valve          h 19,9 mm</p>	<p><b>9834</b></p>
	<p>Bearing h 24,4 mm</p>	<p><b>9835</b></p>
	<p>Bearing h 30,6 mm</p>	<p><b>9836</b></p>



**9270**  
Bearing h 35,1 mm *BH 1 460 324 332*



**9271**  
Bearing h 40,6 mm *BH 1 460 324 331*



**9467**  
Polygonal wrench for solenoid valve  
BOSCH EP/VE pumps



**9585**  
Self-threading puller for oil seal  
on Ø 20 shaft *KDEP 1114*



**9251-AN**  
Thermometro laser new type

# Cables for electronic regulators



Adapter cable for  
 BH VE..R 260-1, VE..R 300-1, VE..R 515, VE..R 575 pumps  
 (BMW - OPEL)

**81.02.430**

*KDEP 1865/1*  
*BH 0 986 612 430*



Adapter cable for  
 BH VE..L 400, VE..R 440, VE..R 440-1, VE..L 323 pumps  
 (AUDI)

**81.02.432**

*KDEP 1865/3*  
*BH 0 986 612 432*



Adapter cable for  
 BH VE..L 450, VE..L 480, VE..L 490, VE..R 560,  
 VE..R 565, VE..R 570, VE..R 627 pumps (IVECO, FIAT, ALFA, LANCIA)

**81.02.434**

*KDEP 1865/5*  
*BH 0 986 612 434*



Adapter cable for  
 BH VE..R 500, VE..L 580, VE..L 580-1,  
 VE..R500-1, VE..R720 pumps (ROVER)

**81.02.437**

*KDEP 1865/8*  
*BH 0 986 612 437*



Adapter cable for  
 BH VE..R 510, VE..R510-1, VE..R 590, VE..R 600, VE..R 638,  
 VE..R 640, VE..R 650, VE..L550, VE..L 650, VE..L 649 pumps  
 (AUDI - VOLKSWAGEN - VOLVO)

**81.02.439**

*KDEP 1865/10*  
*BH 0 986 612 439*



Adapter cable for  
 BH VE..L460, VE..L460-1, VE..L460-2,  
 VE..R530, VE..R530-1 pumps (AUDI)

**81.02.440**

*KDEP 1865/11*  
*BH 0 986 612 440*



Adapter cable for  
 BH VE..R 520 pumps  
 (PSA)

**81.02.441**

*KDEP 1865/12*  
*BH 0 986 612 441*



Adapter cable for  
 BH VE..L 585, VE..R 635 (FIAT, ALFA, LANCIA, CHRYSLER),  
 VE..L 715, VE..L 736 (NISSAN)

**81.02.442**

*BH 0 986 612 442*



Adapter cable for  
 VE..R 576 pumps  
 (BMW 318)

**81.02.443**

*BH 0 986 612 443*



Adapter cable for  
 BH VE..R 650, VE..R 700, VE..R 701,  
 VE..R 705, VE..R 712 pumps (VW)

**81.02.444**

*BH 0 986 612 444*



Adapter cable for  
 BH VE..L694-1, VE..L707 pumps  
 (CHRYSLER)

**81.02.445**

*BH 0 986 612 445*



Adapter cable for  
 BH VE..L688 pumps  
 (FORD)

**81.02.446**

*BH 0 986 612 446*



Adapter cable for  
 VE..R 595, VE..R 641, VE..R 642 pumps  
 (MERCEDES)

**81.02.698**

*BH 0 986 612 698*

# Tools for BOSCH VP pumps



**8122**

Wrench to keep/pull the flange, the shaft and the pulley of VP, DPC, DPCN and DP200 pumps complete with the pin, as phasing reference



**8123**

Flange to install the VP44, VR30 pumps on the test bench the universal support **9680-A** is requested



**8124**

Pair of brackets to install VP44 pumps on the test bench (AUDI application)

*BH 1 688 030 186*



**8119-VP**

Injection control valve (SPV) wrench

*BH 1 986 612 819*



**8114**

Comparator support for phasing of BOSCH VP44 pump mounted on BMW 320-330, FORD FOCUS and so on  
*The point of the device should be always cleaned and free of burr in order not to alter measurement*

*BH 1 688 130 237*



**9754-VP**

Ejector for BOSCH rotative pumps VP44 on BMW 320.330 and hydraulic pump CP1 common rail on BMW



**9754-VP**

Set of 3 gauges for timing holding of VR44 pumps on OPEL VECTRA  
It includes: gauge for engine shaft fixing  
pin for engine shaft fixing and  
pin for pump fixing



**MARBED**<sup>®</sup>  
PROFESSIONAL DIESEL SERVICE TOOLS

# Comparator supports boxes



**9701**



**9702**

**9703**

**9704**

Tool boxes complete with comparator bearings for the survey of delivery start ratio on BOSCH rotating pumps A, B, C and VE type on diesel engines  
*\*(for the included comparator see the below table)*

(*)	1	Centesimal comparator
<b>9347</b>	1	Comparator bearing
<b>9580</b>	1	Comparator bearing
<b>9187</b>	1	Comparator bearing
<b>9186</b>	1	Comparator bearing
<b>9186-A</b>	1	Comparator bearing
<b>9186-B</b>	1	Comparator bearing
<b>9471-09</b>	1	Comparator bearing
<b>15-D3</b>	1	Probe
<b>12-E2</b>	1	Probe
<b>13-E1</b>	1	Probe
<b>13-B1</b>	1	Pair of probe
<b>14-C1</b>	1	Probe
<b>14-C2</b>	1	Probe
<b>15-D1</b>	1	Probe
		Pieces

Box	Comparator (*)
<b>9702</b>	-
<b>9704</b>	 <p><b>9733*</b> 5 mm - 0,01</p>
<b>9701</b>	 <p><b>9087*</b> BH 1 687 233 011 10 mm - 0,01</p>
<b>9703</b>	 <p><b>9348*</b> BH 1 687 233 012 30 mm - 0,01</p>

	<p>Comparator bearing to survey the end stroke on the engine PEUGEOT etc. 14 x 2 mm - with extended probe - 220 mm Ø 4</p>	<p><b>9347</b></p>
	<p>Comparator bearing for BOSCH EP/VE pumps with probe 94 mm Ø 4 thread 2,5 (our art <b>15-D2</b>)</p>	<p><b>9580</b></p>
	<p>Comparator bearing for the delivery start</p>	<p><b>9187</b> <i>KDEP 1026</i> <i>BH 0 986 611 555</i></p>
	<p>Comparator bearing BOSCH EP/VA...B pumps thread 12x1 with probe 25 mm Ø 2 thread 2,5 (our art <b>15-D4</b>)</p>	<p><b>9186</b> <i>KDEP 2940</i> <i>BH 0 986 611 294</i></p>
	<p>Comparator bearing BOSCH EP/VA...B pumps thread 13,5x2</p>	<p><b>9186-A</b></p>
	<p>Comparator bearing BOSCH EP/VA...B pumps thread 12,5x1</p>	<p><b>9186-B</b> <i>KDEP 1002</i> <i>BH 0 986 611 500</i></p>
	<p>Comparator bearing BOSCH EP/VE pumps with probes: 40 mm Ø 4 thread 2,5 (our art <b>13-E1</b>) 58 mm Ø 4 thread 2,5 (our art <b>12-E1</b>)</p>	<p><b>9471-09</b> <i>KDEP 1085</i> <i>BH 0 986 611 754</i></p>
	<p>Probe 52 mm Ø 2 thread 2,5</p>	<p><b>15-D3</b></p>
	<p>Probe 40 mm Ø 4 thread 3</p>	<p><b>12-E2</b></p>
	<p>Probe 58 mm Ø 4 thread 2,5</p>	<p><b>13-E1</b></p>
	<p>Pair of probe (our ref. <b>13-E2</b>) 58 mm Ø 2 thread 3</p>	<p><b>13-B1</b></p>
	<p>Combination of two spindles: our ref. <b>14-C1</b> - 16 mm Ø 4 thread 2,5 our ref. <b>14-C2</b> - 16 mm Ø 4 thread 3</p>	<p><b>14-C</b></p>
	<p>Probe 94 mm Ø 2 thread 2,5</p>	<p><b>15-D1</b></p>





9732 - COMPARATOR BEARING BOX BOSCH PUMPS

## 9732

Dial gauge bearing tool box  
to survey the delivery start  
on rotary and in line BOSCH pumps

# Comparator Bearing Box

# 9732



<b>9733</b>	1	Comparator
<b>9087-A</b>	1	Comparator
<b>9761-A5</b>	1	Reduction
<b>9501</b>	1	Magnet
<b>9186</b>	1	Comparator bearing
<b>9186-A</b>	1	Comparator bearing
<b>9186-B</b>	1	Comparator bearing
<b>9471-09</b>	1	Comparator bearing
<b>9580</b>	1	Comparator bearing
<b>9682</b>	1	Comparator bearing
<b>15-D3</b>	1	Probe
<b>12-E2</b>	1	Probe
<b>13-E1</b>	1	Probe
<b>13-B1</b>	1	Probe
<b>14-C</b>	1	Probe
<b>15-D</b>	1	Probe

Pieces



Centesimal comparator 5mm

**9733**



Centesimal comparator 10mm

**9087-A**

*BH 1 687 233 011*



Comparator reduction from 3 mm to 2,5 mm

**9761-A5**



Magnet for comparator  
thread 2,5

**9501**



Comparator bearing BOSCH EP/VA...B pumps  
thread 12x1  
with probe 25 mm Ø 2 thread 2,5 (our ref. **15-D4**)

**9186**

*KDEP 2940  
BH 0 986 611 294*



Comparator bearing BOSCH EP/VA...B pumps  
thread 13,5x2

**9186-A**



Comparator bearing BOSCH EP/VA...B pumps  
thread 12,5x1

**9186-B**

*KDEP 1002  
BH 0 986 611 500*



Comparator bearing BOSCH EP/VE pumps  
with probes:  
40 mm Ø 4 thread 2,5 (our ref. **13-E1**)  
58 mm Ø 4 thread 2,5 (our ref. **12-E1**)

**9471-09**

*KDEP 1085  
0 986 611 754*



**9580**

Comparator bearing for BOSCH EP/VE pumps  
with probe 94 mm Ø 4 thread 2,5 (our ref. **15-D2**)



**9682**

Comparator bearing  
with probe 94 mm Ø 2 thread 2,5 (our ref. **15-D1**)



**15-D3**

probe 52 mm Ø 2 thread 2,5



**12-E2**

probe 40 mm Ø 4 thread 3



**13-E1**

probe 58 mm Ø 4 thread 2,5



**13-B1**

two probe (our ref. **13-E2**) 58 mm Ø 2 thread 3



**14-C**

Combination of two probes:  
our ref. **14-C1** - 16 mm Ø 4 thread 2,5  
our ref. **14-C2** - 16 mm Ø 4 thread 3



**15-D**

probe 94 mm Ø 2 thread 2,5

# Advance gauge

## 9664-N

The universal body 9664-N can be applied on 5 different types of pumps, depending of the installed interface

## 9664-F

Interface for DPS pumps

## 9664-D

Interface for DPC pumps

## 9664-E

Interface for DP200 pumps

## 9664-H

Interface for VE pumps

## 9664-S

Interface for DENSO pumps

## 9334

Transparent body, spare part of 9664-N

**9664-B**

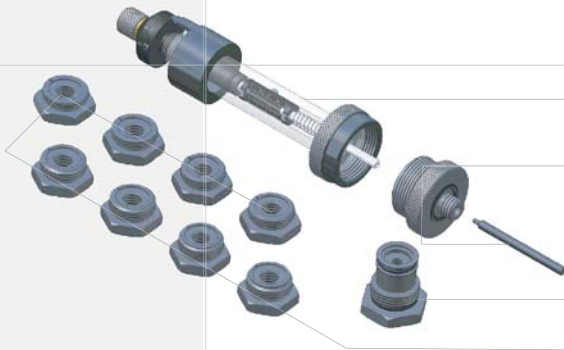

Body **9664-N**

Interface for DPS pumps **9664-F**

Gauge for FORD TRANSIT **1/B**

Set of 8 gauges **1/A**

**9664-C**

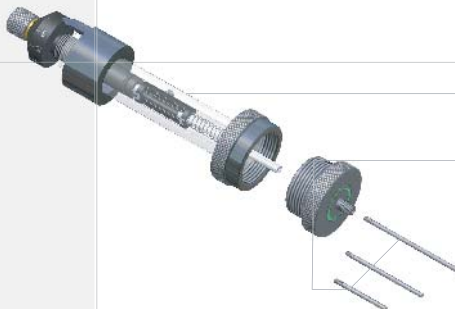

Body **9664-N**

Interface for DPC pumps **9664-D**

**9664-DP**

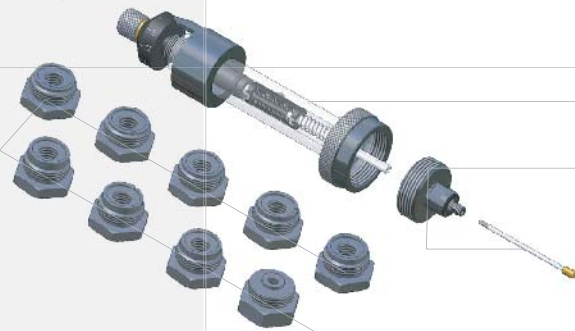

Body **9664-N**

Interface for DP200 pumps **9664-F**

Set of 9 gauges **8041**

**9664-VE**

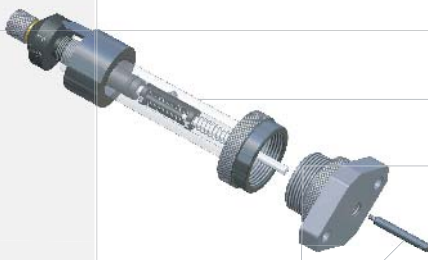

Repalce **9471-01** - Up to 20 BAR

Body **9664-N**

Interface for VE pumps **9664-H**

**9664-ND**

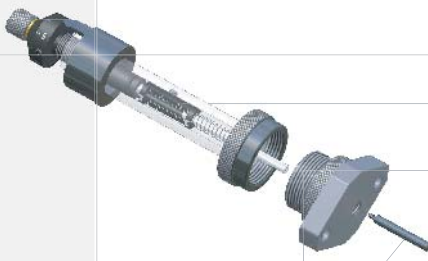

Body **9664-N**

Interface for DENSO pumps **9664-S**





**MARBED**<sup>®</sup>  
PROFESSIONAL DIESEL SERVICE TOOLS

# 9701-A



**9701-A**

Complete box of comparator bearings for the timing of rotative BOSCH EP...VA...VE pumps on diesel vehicles and medium trucks

<b>9733</b>	1	Comparator
<b>9087-A</b>	1	Comparator
<b>9783</b>	1	Comparator bearing
<b>9186</b>	1	Comparator bearing
<b>9471-09</b>	1	Comparator bearing
<b>9580</b>	1	Comparator bearing
<b>9761-A5</b>	1	Reduction
<b>14-C</b>	1	Combination of spindles

Pieces



**9733**

Comparator 5mm - 0,01



**9087-A**

Comparator 10mm - 0,01

*KDEP 2940  
BH 0 986 611 294*



**9783**

Balancing comparator bearing for EP/VA... VE  
thread 8 x 1



**9186**

Comparator bearing BOSCH EP/VA...B pumps  
thread 12x1  
with probe 25 mm Ø 2 thread 2,5 (our art **15-D4**)

*KDEP 2940  
BH 0 986 611 294*



**9471-09**

Comparator bearing BOSCH EP/VE pumps  
with probes:  
40 mm Ø 4 thread 2,5 (our art **13-E1**)  
58 mm Ø 4 thread 2,5 (our art **12-E1**)

*KDEP 1085  
BH 0 986 611 754*



**9580**

Comparator bearing for BOSCH EP/VE pumps  
with probe 94 mm Ø 4 thread 2,5 (our art **15-D2**)



**9761-A5**

Reduction mm 3 - 2,5



**14-C**

Combination of two spindles:  
our ref. **14-C1** - 16 mm Ø 4 thread 2,5  
our ref. **14-C2** - 16 mm Ø 4 thread 3



## 9701-B

Comparator bearing kit for the timing of  
 rotative pumps BOSCH EP/VE  
 (AUDI, FORD TRANSIT, OPEL...)  
*7 arts - 18 particulars*

<b>9733-A</b>	1	Comparator
<b>9580</b>	1	Comparator bearing
<b>9580-A</b>	1	Comparator bearing
<b>9471-09</b>	1	Comparator bearing
<b>9471-09A</b>	1	Comparator bearing
<b>9783</b>	1	Comparator bearing
<b>9783-A</b>	1	Comparator bearing

Pieces



**9733-A**

Centesimal comparator 5 mm  
with back connection (B)



**9580**

Comparator bearing for BOSCH EP/VE pumps  
thread 10 x 1,5  
with probe 94 mm Ø 4 thread 2,5 (our ref. **15-D2**)



**9580-A**

Comparator bearing for BOSCH EP/VE pumps  
thread 10 x 1,5  
with probe 94 mm Ø 4 thread 2,5 (our ref. **15-D2**)



**9471-09**

Comparator bearing BOSCH EP/VE pumps  
thread 8 x 1,5  
with probes:  
40 mm Ø 4 thread 2,5 (our ref. **13-E1**)  
58 mm Ø 4 thread 2,5 (our ref. **12-E1**)

*KDEP 1085  
BH 0 986 611 754*



**9471-09A**

Comparator bearing BOSCH EP/VE pumps  
thread 10 x 1,5  
with probes:  
40 mm Ø 4 thread 2,5 (our ref. **13-E1**)  
58 mm Ø 4 thread 2,5 (our ref. **12-E1**)



**9783**

Balancing comparator bearing for EP/VA... VE  
thread 8 x 1



**9783-A**

Balancing comparator bearing for EP... VE  
for direct injection engines (AUDI, FORD TRANSIT etc...)  
thread 10 x 1,5



**9761-A5**

Reduction mm 3 - 2,5

# 9701-C



## 9701-C

Comparator bearing box for the timing of rotative pumps BOSCH EP/VE (AUDI TDI, OPEL, FORD TRANSIT...)















## 9733

Centesimal comparator - 5 mm

COMPARATOR BEARING						
		8 x 1	10 x 1		8 x 1	10 x 1
PROBE						
1	<b>15-D2</b>	<b>9580</b>	<b>9580-A</b>			
2	<b>15-D4</b>			<b>9186</b>		
3	<b>13-E1</b>				<b>9471-09</b>	<b>9471-09A</b>
4	<b>12-E1</b>					



	CODE	Ø	LENGHT	THREAD	2 PIECES CODE	COMBINATIONS
1	 15-D4	2	25	2,5		
2	 15-D3	2	52	2,5		
3	 15-D1	2	94	2,5	15-D	
4	 14-C1	4	9	2,5		14-C
5	 14-C2	4	9	3		
6	 9761-B5	4	16	2,5		
7	 9761-A5	4	16	3		
8	 12-E1	4	40	2,5	12-A	12-E
9	 12-E2	4	40	3		
10	 13-E1	4	58	2,5	13-B	13-E
11	 13-E2	4	58	3	13-B1	
12	 15-D2	4	94	2,5		





**MARBED**<sup>®</sup>  
PROFESSIONAL DIESEL SERVICE TOOLS

# 9761-A



9761-A - COMPARATOR BEARING BOX FOR ROTARY PUMPS

## 9761-A

Comparator bearing box for  
rotative pumps BOSCH EP...VA...VE,  
CAV DPA, DPC, DPS  
*12 items, 23 pieces*

# 9761-A

## Comparator bearings for rotary pumps



<b>9733-A</b>	1	Comparator
<b>9861</b>	1	Comparator bearing
<b>9761-A1</b>	1	Timing pin
<b>9186-N</b>	1	Comparator bearing - not sold alone
<b>9761-A2</b>	1	Comparator bearing
<b>9761-A3</b>	1	Nut
<b>9761-A4</b>	6	Nut couple
<b>9761-A5</b>	1	Reduction
<b>9761-A6</b>	1	Comparator bearing
<b>9674</b>	1	Timing lock
<b>9761-A7</b>	1	Torx wrench
<b>9761-A8</b>	1	Comparator bearing



**9733-A**

Centesimal comparator 5 mm  
with back connection (B)



**9861**

Comparator bearing for BOSCH VA pumps

1804-606  
1804-607  
1804-600



**9761-A1**

Timing pin on ROTO DIESEL

1084-761



**9186-N**

Comparator bearing BOSCH EP/VA...B pumps  
thread 12x1  
with shaft 25 mm Ø 2 thread 2,5 (our art **15-D4**)

NOT SOLD  
ALONE

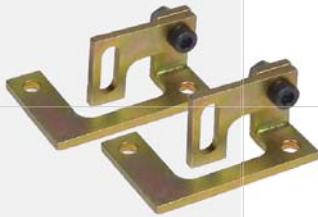

**9761-A2**

Couple of dial indicator for  
ROTO DIESEL pumps

1084-767



**9761-A3**

Fixing nut for flange comparator

1084-764



**9761-A4**

Nut couple to fix to the pump  
the comparator bearing (ns art. **9761-A2**)

1084-766

**9761-A5**

Comparator reduction from 3 mm to 2,5 mm

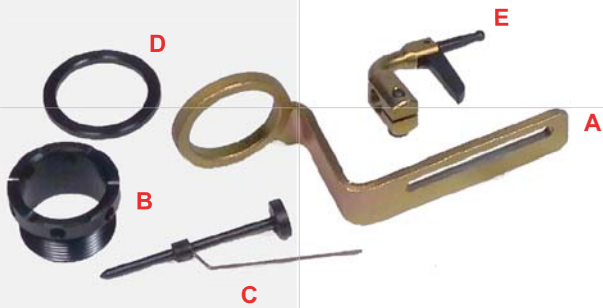
**9761-A6**

Comparator bearing for timing searching on CAV-DPC (5 pieces)

<b>A</b>	<b>9761-B</b>	<b>1804-486</b>	<i>Angle bracket</i>
<b>B</b>	<b>9761-C</b>	<b>1804-487</b>	<i>Union</i>
<b>C</b>	<b>9761-D</b>	<b>1804-488/A</b>	<i>Push rod with guide (54mm)</i>
<b>D</b>	<b>9761-E</b>	<b>1804-489</b>	<i>Distance ring</i>
<b>E</b>	<b>9761-F</b>	<b>1804-491</b>	<i>Equalizer comparator bearing</i>

**9674**

Timing lock for CAV-DPS pumps

CAV 7244-448

**9761-A7**

TORX T25 wrench con with 1,5 mm hole for DPS pumps

CAV 7244-437

**9761-A8**

Comparator bearing composed by 4 pieces for the timing of CAV-DPS pumps and without reduction for the timing of BOSCH EP...VE pumps

 CAV 7244-448  
 KDEP 1085



***[www.marbed.com](http://www.marbed.com)***

---

MARBED Srl - Piazza Novelli, 4 - 20129 Milano - Italy

I. +39 02.71.49.84 - Fax +39 02.70.10.26.67

e-mail [info@marbed.com](mailto:info@marbed.com)